

aquatherm blue pipe

Pipe system made of polypropylene
for chilled, hot fluid and various industrial applications



aquatherm

state of the pipe



Our sales and delivery conditions (January 2014) and the contacts of our technical sales and distribution see on our homepage www.aquatherm.de.

Subject to technical alterations, errors and misprints excepted. With the edition of this catalogue, all former ones become void.



Dear customers and partners,

thank you for your interest in our family enterprise. For a long time the classification of enterprises as a family has rather been hidden than actively marketed. Only in recent years family enterprises experience a comeback. From employee perspective, they are generally a flat hierarchy, provide independent and responsible work under a cooperative management style, but above all they are considered safe employers who commit permanently to their employees.

By definition, family enterprises are distinguished primarily by the unity of ownership and management in the hands of a family; this criterion the aquatherm group still meets after the transition from the first to the second generation (pictured above).

Our self-image of a family enterprise, however, clearly exceeds this description. Our claim describes a proactive organization that bases in the responsible contact in everyday life, that challenges encouraging, thereby accompanies developments in a promoting way and sets on a personal influenced by nearby corporate culture. If these business properties meet determined people that daily inspire through initiative, diligence and passion, until we speak of a living family enterprise, until we speak with pride of the aquatherm family.

We look forward to presenting you on the following pages some insight into our colorful, slightly green-tinted aquatherm world.

Christof Rosenberg
Managing Director

Dirk Rosenberg
Managing Director

Maik Rosenberg
Managing Director

Gerhard Rosenberg
President of the Advisory Board

1973

Founding of aquatherm by Gerhard Rosenberg

1978

Transfer to the first factory in Biggen/D-Attendorf

1985

Completion of factory 1 in Biggen/D-Attendorf

1992

Founding of the branch in Radeberg near D-Dresden

1996

Founding of the metal processing company aquatherm metal, D-Attendorf

1998

Founding of a subsidiary in Carrara/Italy

1999

Completion of the main site in D-Attendorf as one complex (Factories 1+2, Production and Store, Laboratory and Training Centre)

2001

Completion of the extension Factory 2 in D-Attendorf

2001

Opening of the new training centre in D-Radeberg

2002

Completion of the logistics centre in D-Attendorf

2003

Completion of rebuilding and finishing of the training centre in D-Attendorf

2003

30 year celebration of the company aquatherm

2005

Adding of 2 storeys on the administration building

2005/06

Completion of the 4-storey hall on the premises in Attendorf

Basement: Store

Ground floor: Assembly/Packing

1st Floor: Laboratory and Technical department

2nd Floor: Special manifold construction

2008

Aquisition of the former storehouse of the forwarding agent Kost, which also accomodates the room of the plant maintenance.

2009

Opening of the new expertise centre for technical application.

2013

40 year celebration of the company aquatherm

SERVICE

TECHNICAL HOTLINE*

+49 (0)2722 950 200

* free call

info@aquatherm.de www.aquatherm.de

Parent plant Attendorn

aquatherm GmbH
Biggen 5
D-57439 Attendorn
Phone: +49 (0)2722 950 0
Fax: +49 (0)2722 950 100

Subsidiary Radeberg

aquatherm GmbH
Wilhelm-Rönsch-Str. 4
D-01454 Radeberg
Phone: +49 (0) 3528 4362-0
Fax: +49 (0) 3528 4362-30



Field staff

In addition to the regular training service at Attendorn and Radeberg aquatherm field staff are available to assist customers, on site, throughout Germany.



Training service

In addition to training service through the merchant network aquatherm offers its customers training, free of charge, at its training centres at Attendorn and Radeberg.

Fair

aquatherm is represented on all important fairs relevant for the sanitary and heating sector in Germany or abroad with its own exhibition booth. For more information regarding fairs near to you, please visit internet page: www.aquatherm.de.

CERTIFICATIONS IN ACCORDANCE WITH ISO 9001, 14001 & 50001

Since 1996 aquatherm has been meeting the requirements of the certifiable quality management system according to DIN ISO 9001. The 2012 TÜV certificate was extended by the environmental management system according to ISO 14001 and currently by the energy management system according to ISO 50001.

This success is a great contribution and represents a further step to strengthen our competitive position and to meet the high requirements and the responsibility for our customers, partners and the environment.



Laboratory

The aquatherm laboratory: from the testing of granulate through to the finished product the customer can be assured of only the highest quality products.



Software-Service

The aquatherm-software service provides Datanorm-files, an independent graphical program (liNear), and the appropriate training.



Miscellaneous

Different aquatherm-CD's, prospects, catalogues, poster, leaflets, mailings,calen-dars, a.s.m. are investigated and produced from the internal advertising department. All information regarding the company, the technology, the products, the various trainings and fairs as well as all catalogues in pdf-form can be called and downloaded from the aquatherm - website: www.aquatherm.de.

SERVICE

REBRANDING

The desire to avoid stagnation and continuously improve our products, as well as to find new fields of application and create solutions quickly, has resulted in some of the well-known aquatherm product groups. This often led to systems being named as they emerged and has resulted in naming conventions that no longer accurately convey the suitable applications for the pipe.

Another issue is that many of our pipes and systems have names that do not relate to each other, and in turn do not relate those products to their parent company, aquatherm. Furthermore, other companies from different industries around the globe use similar names, creating confusion between aquatherm products and their products. The desired uniqueness of our system identification is lost. Thus, the next logical step for us is to introduce a naming system that matches and unifies our products.

new branding structure								
brand name		appendix						
no.:	company	system	Standard Dimension Ratio	structure of pipe	special feature of pipe	Material / Glas fibre content GF[%]/ fire class. Acc. ISO 11925	old brand name	article-no.
1	aquatherm	green pipe	SDR11	S		PP-R/GF0/E	fusiotherm SDR11	10208 . . . 10248
2	aquatherm	green pipe	SDR7,4	S		PP-R/GF0/E	fusiotherm SDR7,4	10806 . . . 10826
3	aquatherm	green pipe	SDR6	S		PP-R/GF0/E	fusiotherm SDR6	10006 . . . 10024
4	aquatherm	green pipe	SDR7,4	MS			fusiotherm stabi-composite pipe	70806 . . . 70824
5	aquatherm	green pipe	SDR7,4	MF		PP-R/GF7/E	fusiotherm faser composite pipe	70708 . . . 70747
6	aquatherm	green pipe	SDR7,4	MF	UV	inliner like 5 with black PE-coating	fusiotherm faser composite pipe UV	70758 . . . 70788
7	aquatherm	green pipe	SDR7,4	MF	TI	inliner like 5 with PU-Insulation and black PE-casing	fusiotherm faser composite pipe ISO	1270711 . . . 1270737
8	aquatherm	green pipe	SDR9	MF	RP	PP-RP/GF7/E	aquatherm green pipe faser composite pipe	370712 . . . 0370744
9	aquatherm	green pipe	SDR9	MF	RP UV	inliner like 8 with black PE-coating	aquatherm green pipe faser composite pipe UV	370762 . . . 370794
10	aquatherm	blue pipe	SDR11	S		PP-R/GF0/E	Climatherm SDR11	2010208 . . . 2010238
11	aquatherm	blue pipe	SDR7,4/SDR11	MF		PP-R/GF7/E	Climatherm faser composite pipe SDR7,4/SDR11	2070112 . . . 2070726
12	aquatherm	blue pipe	SDR7,4/SDR11	MF	UV	inliner like 11 with black PE-coating	Climatherm faser composite pipe SDR7,4/SDR11 UV	2070162 . . . 2070762
13	aquatherm	blue pipe	SDR7,4/SDR11	MF	OT	inliner like 11 with EVOH O2-barrier	Climatherm faser composite pipe SDR7,4/SDR11 OT	2170114 . . . 2170712
14	aquatherm	blue pipe	SDR17,6	MF		PP-R/GF7/E	Climatherm faser composite pipe SDR17,6	2570134 . . . 2570154
15	aquatherm	blue pipe	SDR7,4/SDR11	MF	TI	inliner like 11 with PU-Insulation and black PE-casing	Climatherm faser composite pipe SDR7,4/SDR11 ISO	2270111 . . . 2270142
16	aquatherm	blue pipe	SDR7,4/SDR11	MF	OT-TI	inliner like 13 with PU-insulation and black PE-casing	Climatherm faser composite pipe SDR7,4/SDR11 OT ISO	2470711 . . . 2470126
17	aquatherm	red pipe	SDR7,4	MF	HI	PP-R/GF7/B-s1,d0	aquatherm firestop	4170707 . . . 4170730
18	aquatherm	lilac pipe	SDR7,4/SDR11	S		PP-R/GF0/E	aquatherm lilac	9010212 . . . 9010238
19	aquatherm	black system			OT		climasystem	
20	aquatherm	orange system		S	OT		aquatherm floor heating	
21	aquatherm	grey pipe					aquatherm SHT	

During the transition period, the products will have the old and the new system name. This will help to facilitate familiarization and orientation in the market.

LEGEND:			
S	single layer	UV	ultraviolet protected
MS	multilayer stabi	TI	isolated with PUR and external PE pipe
MF	multilayer faser	RP	raised pressure (resistance)
OT	oxygen tight	HI	hardly inflammable

potable water	HVACR	swimming pool	chemical fluids	recycled & reclaimed water	fire protection	compressed air	district heating	geothermal	shipbuilding sector
●	○	●	●	○		○	●	●	●
●	○	●	●	○		○	●	●	●
●	○	●	●	○		○	●	●	●
●	○	●	●	○		○	●	●	●
●	○	●	●	○		○	●	●	●
●	○	●	●	○		○	●	●	●
●	○	●	●	○		○	●	●	●
●	○	●	●	○		○	●	●	●
●	○	●	●	○		○	●	●	●
	●	●	●	○		●	●	●	●
	●	●	●	○		●	●	●	●
	●	●	●	○		●	●	●	●
	●	●	●	○		●	●	●	●
	●	●	●	○		●	●	●	●
	●	●	●	○		●	●	●	●
	●	●	●	○		●	●	●	●
	●	●	●	○		●	●	●	●
					●				
				●					
	●								
	●								
●	○								

System recommended due to its technical advantages: ●
 Application of the system is suitable: ○

SHORT CUTS & SYMBOLS

short cuts structure of pipe	
S	single
M	multilayer
MF	multilayer faser
OT	oxygen tight
UV	UV resistant
TI	thermal insulation

short cuts material	
PP	polypropylene
PP-R	polypropylene random
PE	polyethylene

FIELDS OF APPLICATION



potable water application



heating system construction



connection heating and cooling



underfloor heating



wall heating



ceiling heating and cooling



industrial floor cooling



industrial floor heating



chilled water technology



agriculture



sports floor heating and cooling



swimming-pool technology



chemical transport



rainwater application



irrigation



fire protection sprinkler-systems



application in the field of ship building



district heating pipeline systems



geothermal

TABLE OF CONTENTS

Systems & Features	10-29	Installation principles	70-86
Rebranding	6	Fastening technique / Fixed points / Sliding points	70
Short cuts & symbols	8	Installation advice / Linear expansion / Concealed installation	70
aquatherm PP-R pipe systems	10	Installation in ducts	71
Composite technology	13	Open installation / Calculation of the linear expansion	72
aquatherm blue pipe - system overview	14	Linear expansion	73
Material: fusiolen®	16	Pipe clamps	75
Certificates / aquatherm & Ecology	17	Bending side	76
aquatherm blue pipe of	18	Expansion loop / Pre-stress / Bellow expansion joint	77
aquatherm blue pipe ti	19	Length of bending side	78
UV-resistance	24	Length of bending side with pre-stress	79
System extension up to dimension 630 mm	24	Support intervals	80
Fire protection	25	Thermal insulation of hot water pipes	81
Fire load	29	Insulation thickness acc. to Decree of Energy Saving	82
		Pressure test	83
Quality assurance	30-33	Pressure test- pressure diagram	84
Compliance with the system standard / Quality management	30	Pressure test- test record	85
System control / Internal control	31	Pressure test- description of installation	86
External control	33		
		Planning	87-89
Permissible working pressure	34	Coefficient of loss	87
for non potable water			
and general pressure pipe applications in permanent operation		Chemical resistance	90-99
Fields of application	35-43	References	100-110
Reverse return technique	35	Transport and storage	111
Under soil heating	36		
Ice surface cooling	37	Product list	112-163
Industrial floor heating	38	aquatherm blue pipe -pipes	
Heating and air-conditioning	39	Fastening material	
Ship building	40	Fittings	
Compressed air / Swimming pool	41	Weld-in saddle	
Agriculture / Special applications	42	Threaded connections and accessoires	
Application	43	Transition piece	
		Screwed connections and counter parts	
Fusion: Welding technology	44-69	Distributors	
Part A: Assembly of welding tools	44	Valves and accessoires	
Part A: Mounting of the tools	45	Cutting tools, welding devices	
Part A: Heating up phase / handling	46	Welding machines and welding jig	
Part A: Guidelines	47	But welding machines & electrofusion device	
Part B: Checking of devices and tools	47	Peeling tools	
Part B: aquatherm universal peeling tools	48	Saddle welding tools	
Part B: Heating of pipe and fitting	50	Drills & saddle peeling tool	
Part C: Weld-in saddles	51		
Part D: Pulling jig (hitch)	54		
Part E: Welding machine	57		
Part F: Electrofusion device	59		
Part F: Flange connections	62		
Part G: Possibilities of repair	63		
Part H: Butt-welding	64		
Visual inspection of fusion seam	66		
Welding parameters	68		

aquatherm blue pipe

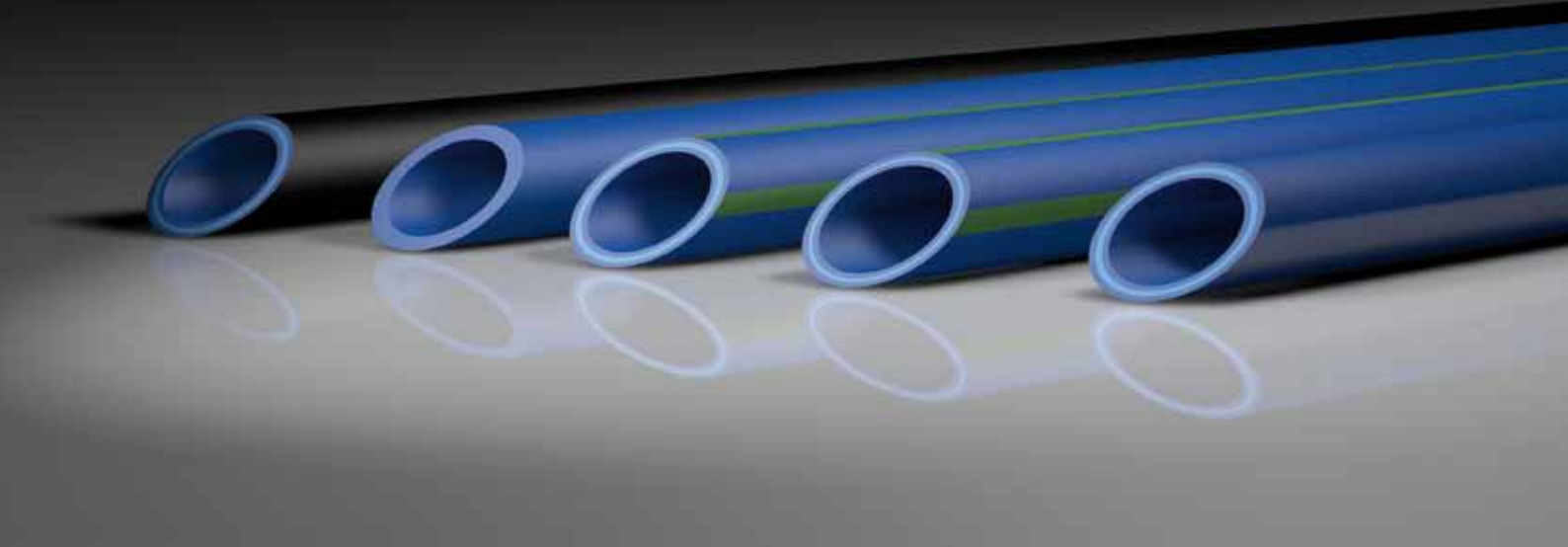

AQUATHERM PP-R PIPE SYSTEMS

aquatherm offers pipe systems with many applications due to their special characteristics and versatility.

The aquatherm pipe systems are applied in all fields of

NEW INSTALLATION

REPAIR and

RENOVATION.

AQUATHERM BLUE PIPE

climatherm our specialty for distributing cooling and heating in closed systems as well as in several industrial applications, will become

aquatherm blue pipe

This system was developed 10 years ago in order to prevent corrosion in air conditioning pipes and quickly expanded its range of application, with many positive features for other fields of piping installation. It has gone on to find success around the world in hotels, stadiums, schools, offices, and industrial applications.

The aquatherm blue pipe system has been developed especially for applications outside the potable water installation.

In addition to the general advantages of the PP-R pipesystem (see page 13) aquatherm blue pipe in comparison with the aquatherm green pipe system offers higher volumetric current values due to smaller wall thickness.

System components

The system has to be installed in combination with the aquatherm green pipe-fittings - and includes all elements for the pipe system installation for chilled, hot fluid and various industrial applications.

- pipes in straight lengths and/or coils
- fittings
- flanged joints
- water point connections and accessories
- welding devices and machines
- weld-in saddles
- manifolds
- shut-off devices
- cutting and peeling tools
- installation guide and fastenings
- transition joints from PP-R to metal or from metal to PP-R

aquatherm blue pipe stopps corrosion damages!

Air conditioning systems (problems with dew-point) installed with steel pipes especially are affected by corrosion at the outer surface of the pipes.

aquatherm blue pipe is manufactured from 100% corrosion resistant materials which increase the life-time of air-conditioning pipe systems considerably.



corroding steel pipes

Insulation against energy loss

Due to its excellent thermal insulation properties aquatherm blue pipes compared to metal pipes require a considerably thinner insulation.

For detailed information see table on page 81.

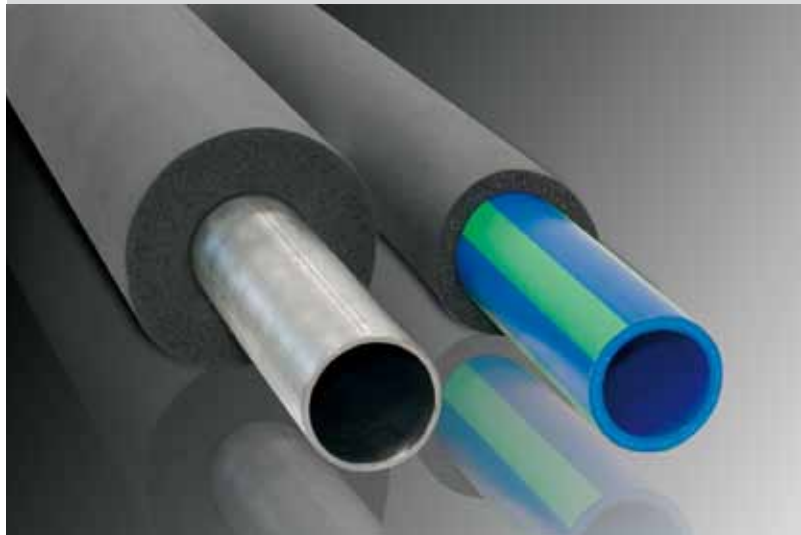

aquatherm pipe systems

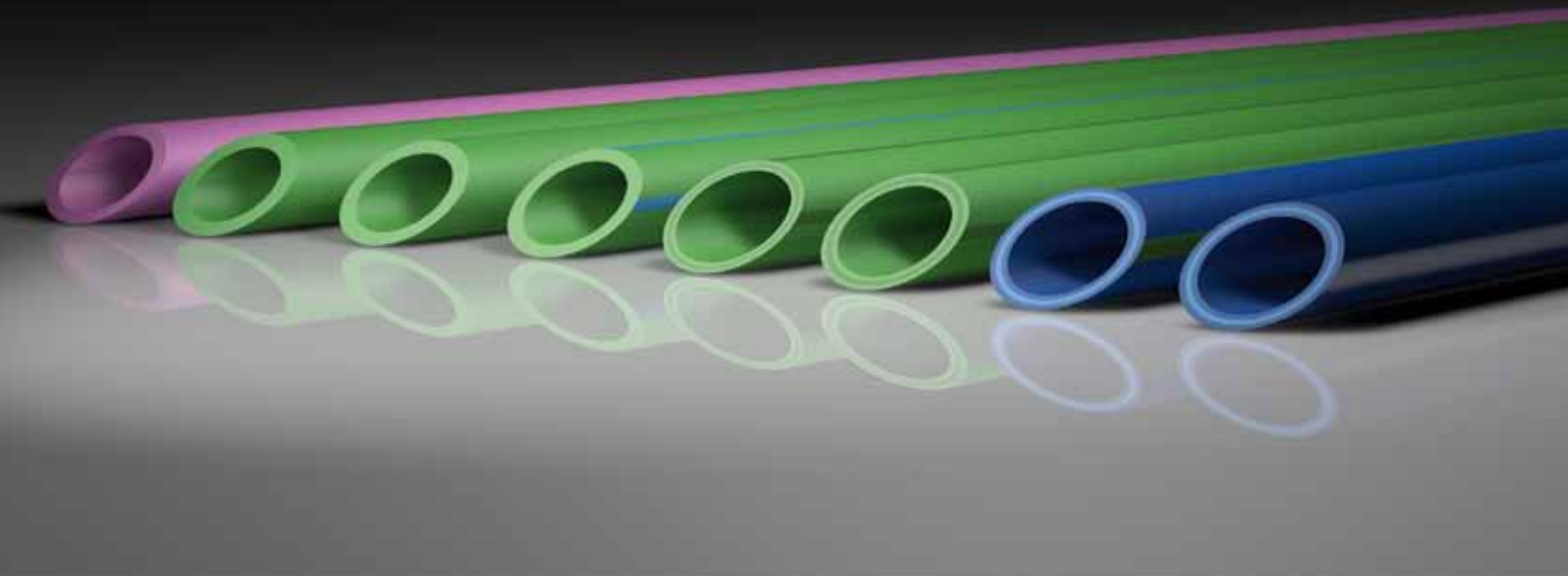

FIELDS OF APPLICATION

- **Heating pipes for residential houses**

heat generator connections
 heating manifolds
 risers
 high rise
 manifold connections
 radiator connections

- **Pipe networks**

for climate technology
 for Chilled water technology
 for Swimming-pool technology
 for Chemical transport
 for Rainwater application
 for Compressed air systems
 for Under-floor-heating-systems
 in ship building
 for District heating
 for Geothermal

AQUATHERM PIPE SYSTEMS

Characteristic

aquatherm PP-R pipe systems stopping corrosion damages. All materials are corrosion resistant and - compared to metallic pipes - have less noise flow rate. aquatherm PP-R pipes are opaque - no danger of algae development.

Installation

aquatherm offers an unique and unrivalled connection process: material union by fusion. Shortest connection times are convincing:

e.g. outside diameter 20 mm = 5 sec.

aquatherm pipe connections can be hydraulic pressure tested or put into operation directly after their fusion. There are no extended waiting times.

Quality

This is reflected in national and international certificates, but above all in the satisfaction of aquatherm-clients, installers and planners. For more details regarding quality and certificates see page 30.

Guarantee

As a statement to aquatherm quality standards the aquatherm PP-R pipe systems carries a 10 year guarantee for pipe and fittings with a product liability of 15 Mio. EUR per damage event.

Price

aquatherm PP-R pipe systems are perfected pipe systems of high quality material with an optimum cost-performance ratio.

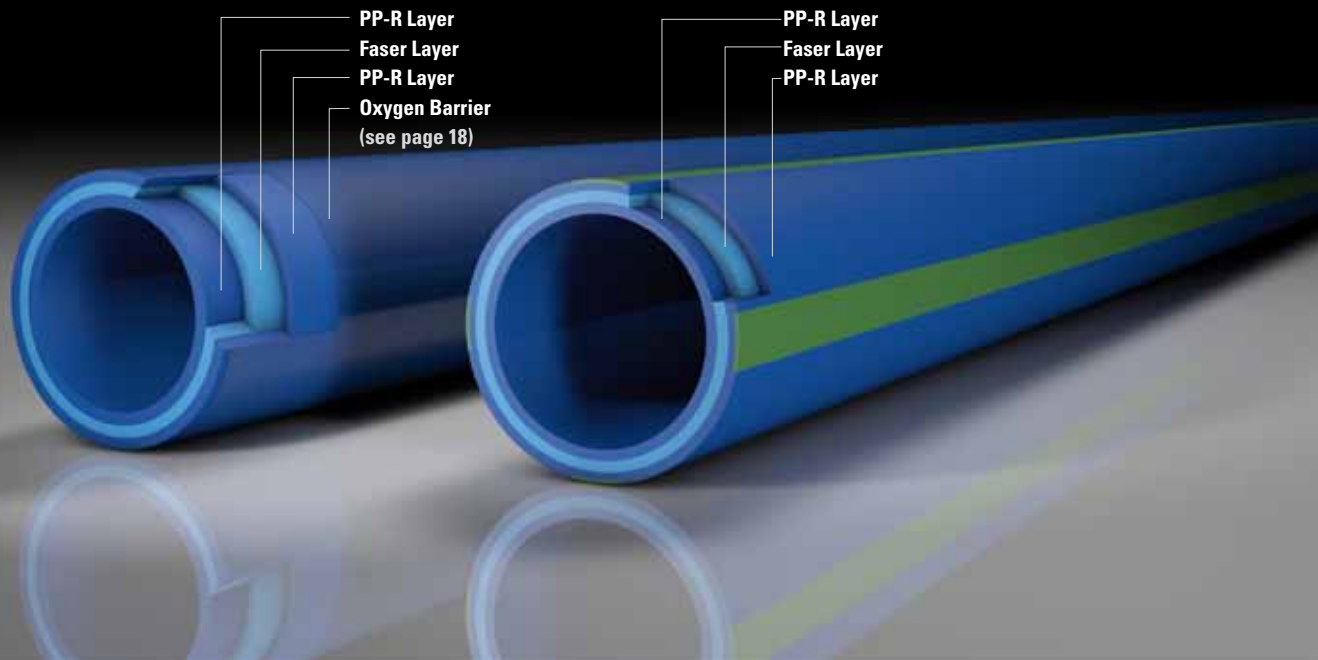

FASER COMPOSITE TECHNOLOGY

The composite pipes made in the multi-layer extrusion process produce a higher stability due to the fibre filling in the middle layer. Compared to customary PP-pipes there are further advantages.

aquatherm developed a manufacturing method, realizing the integration of a special faser mixture within the material polypropylene.

The result of this innovative technology is the singular compound of the different materials.

- The linear expansion is reduced by at least 75 % compared with standard PP-pipes
- The flow rate is increased by 20 % due to smaller wall thickness.
- High stability
- The coefficient of linear expansion is nearly identical to that of metal pipes, so that compared with usual plastic pipes the support intervals can be enlarged and the number of clamps can be reduced.
- Optimum cost-performance ratio
- Lower weight
- High impact rate
- Simply cut and weld

A diagram for the simple and rapid determination of the length expansion and expansion compensation is on page 72.

aquatherm blue pipe

OVERVIEW



COMPARISON OF THE WATER CONTENT PER METER

ø Dimension mm	aquatherm blue pipe SDR 7,4 MF SDR 7,4 MF OT	aquatherm blue pipe SDR 11 MF SDR 11 MF OT SDR 11 S	aquatherm blue pipe SDR 17,6 MF
ø 20	0,163	0,206	-
ø 25	0,254	0,327	-
ø 32	0,423	0,539	-
ø 40	-	0,834	-
ø 50	-	1,307	-
ø 63	-	2,074	-
ø 75	-	2,959	-
ø 90	-	4,252	-
ø 110	-	6,359	-
ø 125	-	8,199	9,637
ø 160	-	13,430	15,792
ø 200	-	21,010	24,661
ø 250	-	32,861	38,568
ø 315	-	52,172	61,223
ø 355	-	66,325	77,832
ø 400	-	84,290	98,756
ø 450	-	106,477	125,036
ø 500	-	-	154,272
ø 560	-	-	193,688
ø 630	-	-	245,070

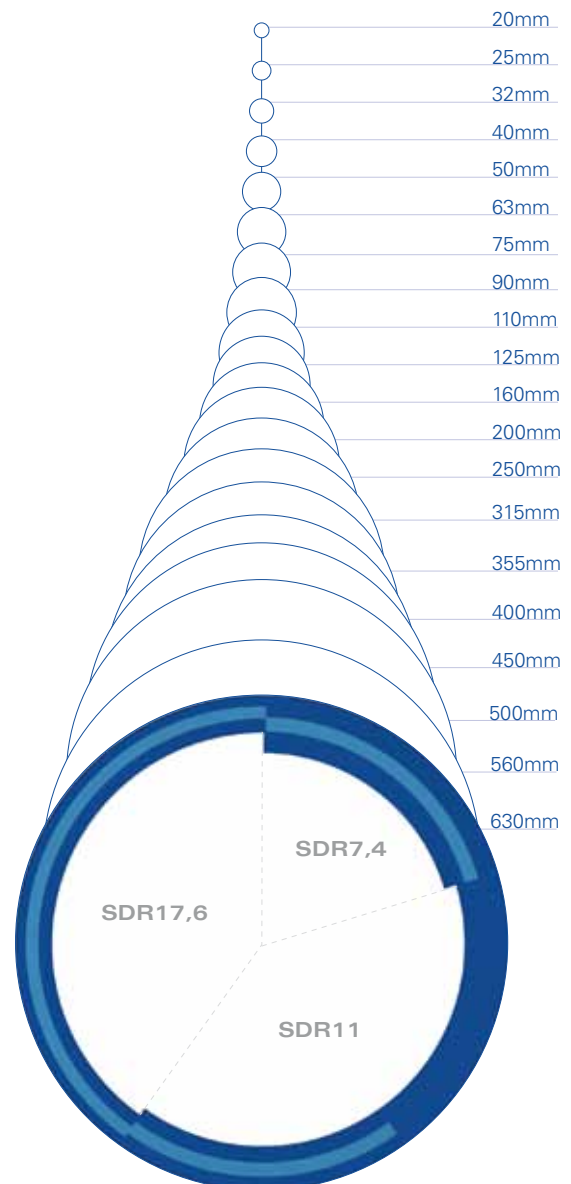

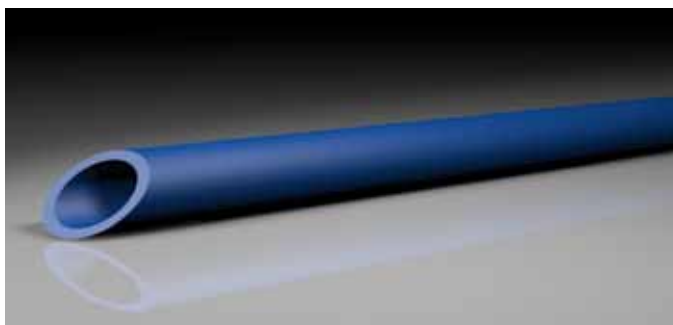

SDR: 11
ø: 20-32mm

Type of pipe:

Old (before March 2013): climatherm pipe
New (since March 2013): aquatherm blue pipe S



SDR: 7,4 **ø:** 20-32 mm
SDR: 11 **ø:** 32-450 mm
SDR: 17,6 **ø:** 160-630 mm

Type of pipe:

Old (before March 2013): climatherm Faser composite pipe UV
New (since March 2013): aquatherm blue pipe MF UV

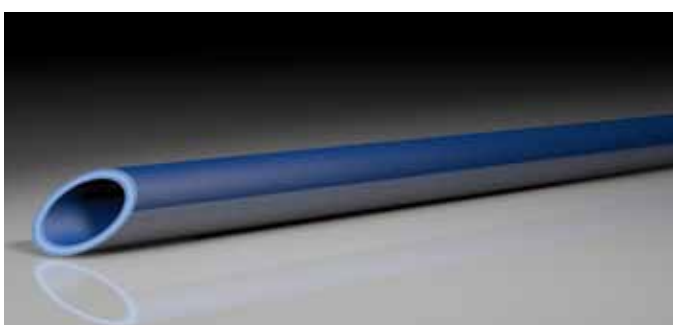

SDR: 7,4 **ø:** 20-32 mm
SDR: 11 **ø:** 40-250 mm

Type of pipe:

Old (before March 2013): climatherm Faser composite pipe OT
New (since March 2013): aquatherm blue pipe MF OT

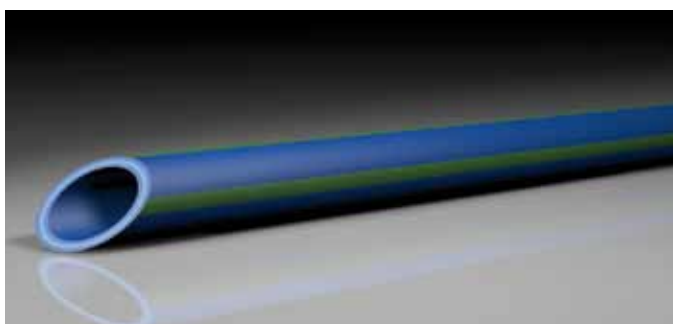

SDR: 7,4 **ø:** 20-32 mm
SDR: 11 **ø:** 32-450 mm
SDR: 17,6 **ø:** 125-630 mm

Type of pipe:

Old (before March 2013): climatherm Faser composite pipe
New (since March 2013): aquatherm blue pipe MF



SDR: 11 **ø:** 32-450 mm
SDR: 17,6 **ø:** 160-450 mm

Type of pipe:

Old (before March 2013): climatherm ISO Faser composite pipe
New (since March 2013): aquatherm blue pipe MF TI



The advantages

of aquatherm pipes and fusiolen® PP-R

- absolutely corrosion resistant**
- resistant against chemicals**
- high environmental compatibility**
- high impact rate**
- less pipe roughness**
- heat and soundinsulating characteristics**
- very good welding properties**
- high heat-stabilized**
- noticeable less insulation - recommended are 10 mm of insulation for all pipe dimensions**
- high stability**
- lighter in weight**
- easy processing**
- well-priced**
- installation aids and fixings**

fusiolen®

OUR MATERIAL FUSIOLEN PP-R

Decades of experience in the production and the application of PP-R pipe systems and the current ambition of continuous development led to numerous improvements of the aquatherm-system technology.

Newly opened markets set a high standard of quality to make even larger demands against the pipe material. Various fields of application require the greatest possible independence of the material to be processed. Raw materials with new properties are required.

aquatherm has developed and produced their own, innovative PP-R materials which meet the requirement of a global market in the potable water and heating technology, in the airconditioning and chilling engineering, in the industrial and agriculture economy, in shipbuilding as well as in fire protection. Successful results of this research are fusiolen® PP-R, fusiolen® PP-R C or fusiolen® PP-R FS.

All aquatherm PP-R pipes and fittings are made of fusiolen® PP-R.

Special heat and extraction stability are only two of the features of this material. Its physical and chemical properties are well-suited to the transfer of potable water and to the heating field. Above all, the good welding properties and fusion, resulting in a permanent connection, have made the aquatherm systems and the raw material fusiolen® PP-R well known worldwide.

Environment

The environmentally friendly material polypropylen fusiolen® PP-R is recyclable and can be ground, melted and reutilised for various applications e.g. motor-protections, wheel linings, laundry baskets and other kinds of transport boxes. There are no polluting substances with PP-R either in its processing or in its disposal.

fusiolen® PP-R – for the benefit of our environment!

Use of metal deactivators

By adding suitable food-approved additives the risk of amaterial damage caused by metal under extreme conditions of application is substantially reduced.

Higher long-term heat stabilization

The long-term heat stabilization has been increased to resist to the potential effects of peak temperatures within higher safety parameters.

MATERIAL PROPERTIES

The extrapolated service life of aquatherm PP-R-pipes is more than 50 years. Peak temperatures of 100° C arising from short disruptions are unproblematic.

Permanent temperatures from 70°C up to 90° C reduce the service life of the pipe (see table "Permissible Working Pressure", page 34).

Using aquatherm PP-R pipes for heating or air conditioningapplications the pressure- and temperature conditions according to table "Permissible Working Pressure" are valid.

The following table shows the operating conditions related to pressure and temperature as a basis for pipe and pipe connections.

These figures refer to potable water installations based on a theoretical service life of 50 years.

Certificates

Numerous international certificates testify to the high quality standard of the aquatherm pipes.

- DVGW, SKZ (Germany)**
- AENOR (Spain)**
- ÖVGW (Austria)**
- WRAS (UK)**
- SVGW (Switzerland)**
- KIWA (Netherlands)**
- SAI-Global (Australia)**
- CRECEP (France)**
- SII (Israel)**
- SIRIM (Malaysia)**
- TIN (Poland)**
- LNEC (Portugal)**
- SITAC (Sweden)**
- NSF, ICC (USA)**
- a.m.m.**



* Reference temperature for the creep rupture strength:
20°C (68°F)

	Working pressure	Temperature	Annual working hours
	bar (psi)	°C (°F)	h/a
Cold water	0 upto 10 (145) transient	to 25 (77)*	8760
Hot water	0 upto 10 (145) transient	to 60 (140) to 85 (185)	8710 50

AQUATHERM & ECOLOGY

Environmental protection is taken very seriously by aquatherm!

Products such as the aquatherm PP-R pipe systems feature not only a long service life, but also excellent environmental and social compatibility.

From the origin of the company aquatherm placed emphasis on the fact that its products and manufacturing processes should not pollute our sensitive ecosystems, and ensured development of fully recyclable materials which can thus be added, problem-free, to new production.

Long before environmental protection was recognised as a global issue aquatherm fulfilled ecological standards which are demanded today.

For now 40 years aquatherm has underlined its philosophy that ecological and economic interests should not be contradictory, neither during production and sales, nor in the product application.

The environmentally friendly raw material fusiolen® its used for the manufacture of the aquatherm pipe systems. To ensure its environmental compatibility the basic material polypropylene, as well as all contained additives (colour pigments and stabilizers) were extensively tested, not only by aquatherm’s own laboratory, but also by independent laboratories.

Their results show that the material fusiolen® and the pipe systems from which it is manufactured, comply with the highest ecological standards and are thus future-oriented.

aquatherm blue pipe ot
SPECIAL TECHNICAL FEATURES

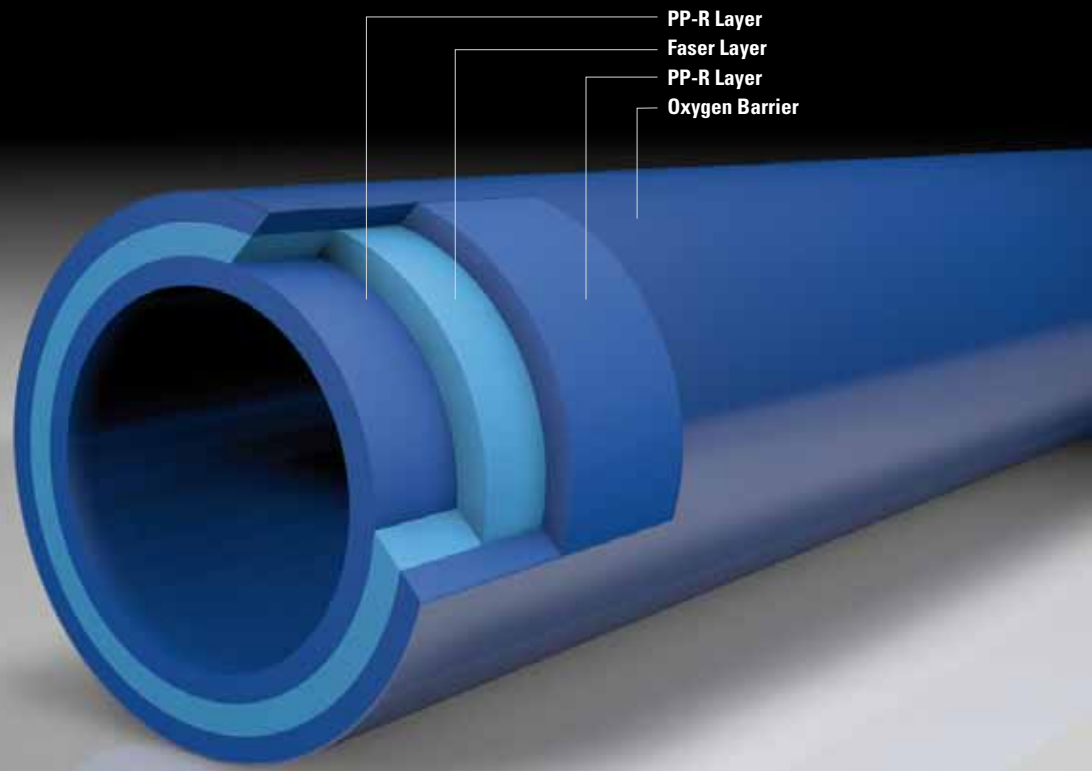

aquatherm blue pipe ot

WITH OXYGEN BARRIER

With the redeveloped aquatherm blue pipe faser composite pipe OT, aquatherm launches an oxygen tight pipe, which is equipped with an oxygen barrier and thus corresponds to the requirements of DIN 4726.

The aquatherm blue pipe faser composite pipe OT in combination with the aquatherm blue pipe system includes all elements for the pipe installation of chilled, hot fluid and various industrial applications.

The advantages of aquatherm blue pipe ot:

- oxygen tight by diffusion barrier
- certified according to DIN 4726
- absolutely corrosion resistant
- less pipe friction
- high stability
- high heat-stability
- high environmental compatibility
- high impact rate
- resistant against chemicals
- heat- and sound insulating characteristics
- very good welding properties
- considerably thinner insulation

Easy and quick installation technology

aquatherm blue pipe faser composite pipe OT also convinces by easy but effective installation- and connection technology. By heating of pipe end and fitting the plastic melts after joining of the elements into a permanent connection. aquatherm blue pipe faser composite pipes OT have to be peeled with peeling tools Art.-No. 50506-50526 before processing.

aquatherm blue pipe ti
SPECIAL TECHNICAL FEATURES

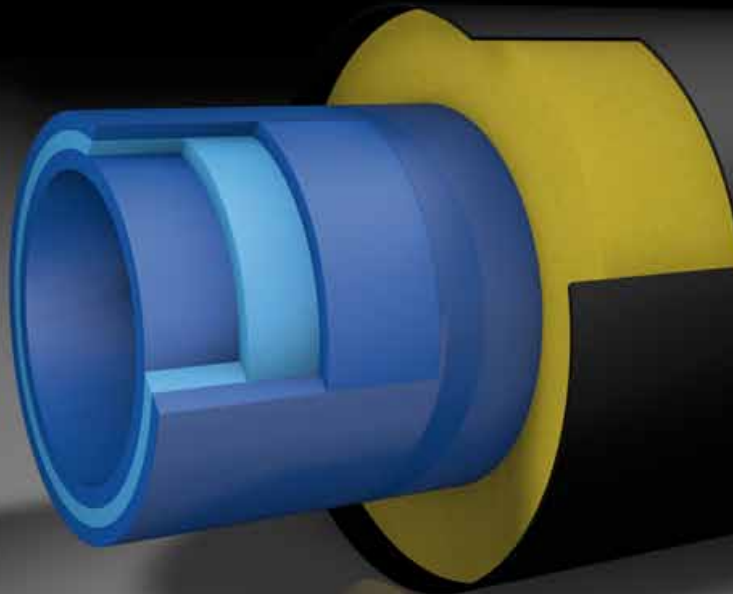

aquatherm blue pipe ti
PRE INSULATED PIPE SYSTEMS FOR DISTRICT HEATING

For the transport of district heating energy over long distances a complex, mostly underground pipe system is required. High demands are made on both, the medium pipe and the pipe insulation.

aquatherm offers with the factory insulated aquatherm blue pipe ti-fiber composite pipes the ideal district heating pipes for heating systems, which are operated with working pressures up to 20 bar and working temperatures up to 90° C.

The insulated aquatherm blue pipe fiber composite pipes are also used as cooling- and refrigerant agent pipes. The pipe insulation is factory-made with PUR rigid foam that surrounds the medium pipe all over. To protect the insulation layer outward against mechanical or weather-related influences, the outside coating consists of a PEHD-protection pipe.

Fittings such as elbows, bends or tees are insulated at the factory in the same design. The joints between pipe and fitting are manufactured locally at the site in the pipe dimension 32 up to 125 mm by socket welding and in the dimension 160 up to 315 mm by butt-welding process.

The insulation of these joints is done by insulation sockets that enable a continuous insulation of the district heating pipeline.

aquatherm district heating pipes are available in length of 5.8 m and 11.6 m. We offer fittings with leg lengths of 0.5 m and 1.0.

Special designs on request.

Medium pipes

- ➡ **aquatherm blue pipe ti** -
 fiber composite pipe system SDR 11/17,6
 pipe system for heating, cooling and waste water
 in dimensions DN25 – DN300

- ➡ **aquatherm blue pipe ot ti** -
 fiber composite pipe system SDR 11
 oxygen-tight pipe system for heating- and industrial
 in dimensions DN25 – DN100

Fields of application

System recommended due to its technical advantages: ●

**aquatherm
 blue pipe ti**

**aquatherm
 blue pipe ot ti**

	aquatherm blue pipe ti	aquatherm blue pipe ot ti
Climate technology	●	●
Chilled water technology	●	●
Swimming pool technology	●	
Rainwater application	●	
Irrigation	●	
District heating pipeline systems	●	●
Application in the field of Shipbuilding	●	●
Industrial liquids considering the material resistance	●	●

aquatherm ti SYSTEM ADVANTAGES

System recommended due to its technical advantages: ●

Application of the system is suitable: ○

aquatherm blue pipe ti

aquatherm blue pipe ot ti

	aquatherm blue pipe ti	aquatherm blue pipe ot ti
Low expansion	●	●
Corrosionresistant	●	●
Very good welding properties	●	●
Less pipe friction	●	●
High impact resistance	●	●
Heat-stability	●	●
Metal deactivation	●	●
Recyclable	●	○
Sound- and heat insulation	●	●
Low weight	●	●
Self-compensating	●	●

DIMENSIONS

medium pipe	aquatherm blue pipe ti faser composite pipe SDR 11	aquatherm blue pipe ot ti faser composite pipe SDR 11	aquatherm blue pipe ti faser composite pipe SDR 17,6	casing pipe
external diameter	dimension	dimension	dimension	external diameter
32 mm	DN 25	DN 25	-	90 mm
40 mm	DN 32	DN 32	-	110 mm
50 mm	DN 40	DN 40	-	110 mm
63 mm	DN 50	DN 50	-	125 mm
75 mm	DN 65	DN 65	-	140 mm
90 mm	DN 80	DN 80	-	160 mm
110 mm	DN 80/100	DN 80/100	-	200 mm
125 mm	DN 100	DN 100	DN 100	225 mm
160 mm	DN 125	DN 125	DN 150	250 mm
200 mm	DN 150	DN 150	DN 200	315 mm
250 mm	DN 200	DN 200	DN 250	400 mm
315 mm	DN 250	-	DN 300	450 mm

* larger dimensions on request



aquatherm ti INSULATION

Material

The aquatherm ti pipe systems are insulated with PUR-rigid foam. This polyurethane foam is made of Polyol and Isocyanate and meets the functional requirements of the EN 253. The foam is homogene with an average cell size of max. 0,5 mm.

For the professional insulation of the pipe and fitting connections, insulation jackets made of PUR-rigid foam are available for the aquatherm ti pipe system, coated with shrink sockets resulting in a permanent connection with the casing pipes.

Material parameters

Technical data	PUR
Cell gas Cyclopentane	> 8 %
Core density	> 60 kg/m ³
Closed cell	> 88 %
Water absorption	< 10 % (Vol)
Compression strength 10 % deformation	> 0.3 N/mm ²
Shearing resistance	> 0.12 N/mm ²
Tangent shearing resistance	> 0.20 N/mm ²
Thermal conductivity at 50° C	< 0.03 W/mK

aquatherm ti LOSS OF HEAT AND COOLING ENGERGY

Type of pipe	Heat loss at average temperature 40°C in W/m	Heat loss at average temperature 50°C in W/m	Heat loss at average temperature 65°C in W/m
aquatherm blue pipe & aquatherm blue pipe of SDR 11			
32 mm	6,86	8,57	11,14
40 mm	6,92	8,65	11,24
50 mm	8,87	11,08	14,41
63 mm	10,10	12,62	16,41
75 mm	10,99	13,74	17,86
90 mm	11,80	14,75	19,17
110 mm	11,27	14,08	13,81
125 mm	11,43	14,29	18,57
160 mm	14,83	18,54	24,10
200 mm	14,60	15,25	23,73
250 mm	14,15	17,69	23,00
315 mm	18,30	22,88	29,74

Type of pipe	Cooling engergy loss at average temperature 8°C in W/m	Cooling engergy loss at average temperature 15°C in W/m	Cooling engergy loss at average temperature 21°C in W/m
aquatherm blue pipe und blue pipe of SDR 11			
32 mm	1,29	2,57	3,60
40 mm	1,30	2,59	3,63
50 mm	1,66	3,33	4,66
63 mm	1,89	3,79	5,30
75 mm	20,60	4,12	5,77
90 mm	2,21	4,42	6,19
110 mm	2,11	4,13	5,92
125 mm	2,14	4,29	6,00
160 mm	2,78	5,56	7,79
200 mm	2,74	5,48	7,67
250 mm	2,65	5,31	7,43
315 mm	3,43	6,86	9,61
aquatherm blue pipe SDR 17,6			
125 mm			
160 mm	2,78	5,74	8,04
200 mm	2,82	5,65	7,91
250 mm	2,74	5,47	7,66
315 mm	3,57	7,14	10,0

aquatherm ti CASING PIPES - MATERIAL

The casing pipes of the aquatherm ti pipe system are made of the material PE according to DIN EN 8075. Like insulated steel pipes correspond to the EN 253, aquatherm applies casing pipes, which correspond to the technical requirements of this standard.

The material is characterized by the following mechanical and thermal features.

Material parameters

Technical data	PE 80
Density, g/cm ³ , ISO 1183	0.950
Yield stress, MPa, DIN EN ISO 527	22
Elongation at yield stress, %, DIN EN ISO 527	9
Elongation at break, %, DIN EN ISO 527	300
Tension-E-module, MPa, DIN EN ISO 527	800
Impact strength, kJ/m ² , DIN EN ISO 179	without break
Impact strength, kJ/m ² , DIN EN ISO 179	12
Ball impression hardness, MPa, DIN EN ISO 2039-1	40
Shore hardness, D, ISO 868	63
Medium thermal expansion coeff., K-1, DIN 53752	$1.8 \cdot 10^{-4}$
Thermal conductivity, W/m · K, DIN 52612	0.38
Electric strength, kV/mm, VDE 0303-21	47
Surface resistance, Ohm, DIN IEC 167	10^{14}
Inflammability, DIN 4102	B2
Physiological harmlessness acc. to BgVV	yes
Chemical resistance acc. to DIN 8075 supplement	complied with
Thermal operating conditions	°C -40 to +80

RING STIFFNESS OF aquatherm blue pipe

The aquatherm blue pipes SDR 11 MF (90-400 mm) and SDR 17.6 MF (160-630 mm) have been tested according to DIN EN ISO 9969 with 3% pipe deformation and have a ring stiffness of $\geq 16 \text{ KN/m}^2$. Thus, they are classified in the ring stiffness class SN16, which corresponds to the highest standard category.

Underground installation: The depth of the trench adds up from the depth of the frost line, the outer diameter of the pipe and the height of the bedding (**A**+**Da**+**B**). The frost line must be observed: 0.5 m – 9.0 m above the pipe peak (E). If the pipes are installed outside the specified laying depth, a load distribution by steel or concrete slabs must be installed.

Traffic load: SLW 60, heavy forklift (60 tons maximum load).

Trench design: Recommended calculation according to ATV A 127 (basis for calculation).

Laying conditions: We recommend laying the pipes in a narrow trench in which nevertheless sufficient space for working is available.

Bedding layer (B): In normal soil 100 mm sand with round graining size 0-8 mm.
When rock or rocky soils 150 mm sand with round graining size 0-8 mm.
This layer is equally compressed ($\geq 97\%$ Proctor) with gaps in the socket area. Non sustainable soils are made stable by the choice of the bedding layer. Note planning requirements.

Backfilling: The building material 4/8 mm graining is filled in layers in order to construct the lateral bedding (**C**) and the covering (**D**). Thereby the peak of the pipe (**E**) is covered with minimum 100 mm. Then the main filling (**F**) with the excavation can be carried out. Note that the grain size does not exceed 300 mm respectively sharp and rough stones are removed. Planning requirements of the filling levels are always to be considered.
Each filling is compressed separately.

Compaction: The compression ($\geq 97\%$ Proctor) of the lateral bedding (**C**) and the covering (**D**) is done by hand or with light equipment. If the main filling is made with minimum 20 cm, the trench can be compressed 95 % Proctor upwards from this layer with heavy equipment. The last 50 cm of the trench are compressed with 97 – 100 % Proctor.

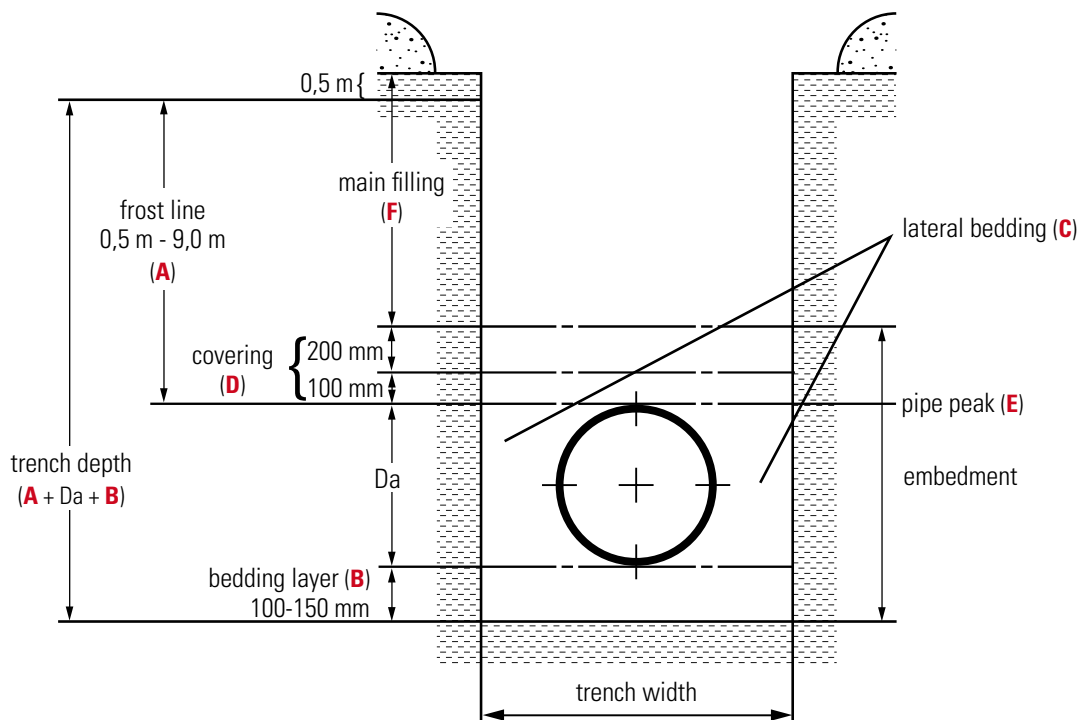

aquatherm ti MORE INFORMATION

For more information on the aquatherm ti-system, please see our aquatherm ti-catalogue with the order-no. **E30000**. You can request at our Info-Service on telephone-no. **+49 2722 950-0** or download in the download area of our website **www.aquatherm.de**.

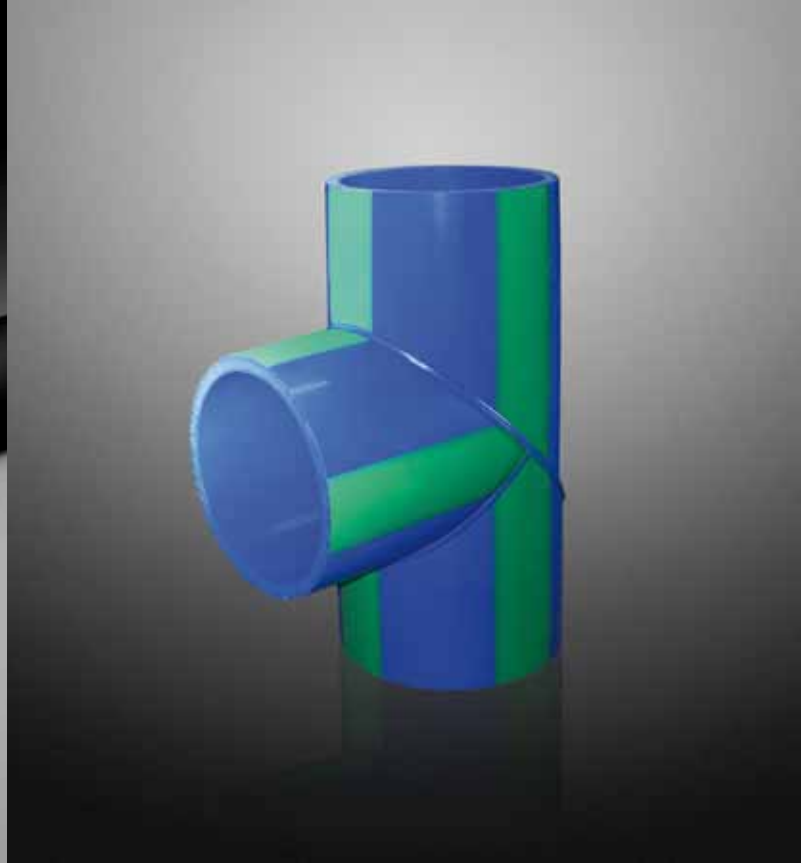
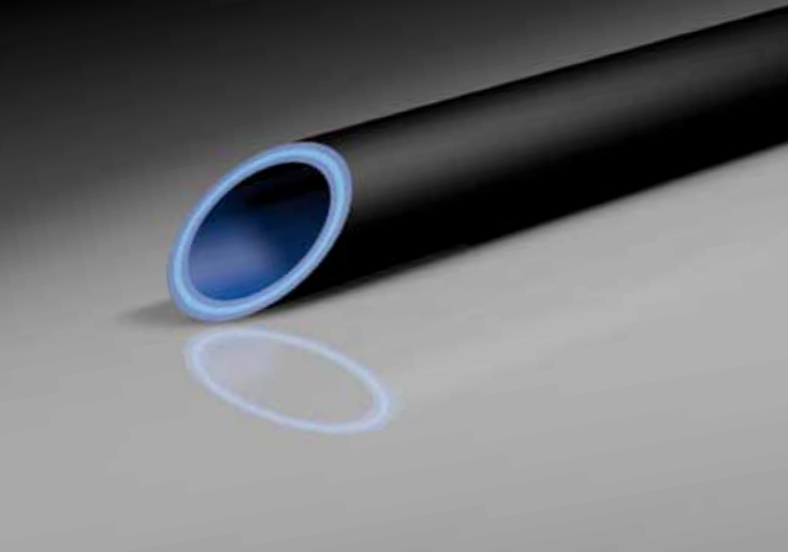

UV-RESISTANCE

Pipes made from fusiolen® PP-R and fusiolen® PP-R C are normally not installed where subject to UV-radiation.

All aquatherm PP-R pipes and -fittings have UV-stabilizer to bridge transport and installation times. Maximum storage time in the open air is 6 months.

For the application in open air aquatherm offers composite pipes with UV-protective layer made from polyethylene, which excludes damages caused by sunlight.

aquatherm PP-R pipes with UV-protection are always available in stock.

Available types of pipe: aquatherm blue pipe MF und aquatherm blue pipe MF ot.

UV ADHESIVE TAPE

As an alternative to our pipes, factory-equipped with UV protective layer, the wrapping with UV tape is possible, e.g. when fittings or short pieces of pipe must be protected.

Therefore an elastic tape with good resistance to abrasion, moisture, oils, mild acids and alkalis and outdoor weather influences should be selected. The tape should always be applied to a dry, clean and grease-free surface. The winding should be performed with slight pulling and at least 50 % overlap.

Further information on page 117.

SYSTEM EXTENSION UP TO DIMENSION 630 MM

Responding to the requirements for pipe systems with bigger flow volume in industrial plants, factories, gigantic construction projects in hotel building, universities and stadiums aquatherm now offers the extension of aquatherm blue pipe in the dimensions 400 mm, 450 mm, 500 mm, 560 mm and 630 mm.

Considering the following well-established advantages of the pipes and fittings made from fusiolen PP-R and connected by butt-welding, aquatherm succeeded, as the first pipe system manufacturer worldwide, in the production of fiber composite pipes, connecting pieces and joints in these big dimensions.

Pipe system for heating and climate technology

For the application in heating and climate technology, wether in manifold construction as risers or distribution pipes or for the transport of various media on longer distances, e.g. for district heating, the aquatherm blue pipe system now provides a wider field of applications.



FIRE PROTECTION

The aquatherm PP-R pipe systems comply with the requirements of the fire classification B2 DIN 4102 (normal inflammable). Compared to natural products like wood, cork or wool, aquatherm PP-R - pipes do not produce any gas toxicity. In case of fire, there is no risk of dioxin emissions. To avoid fire and smoke transmission aquatherm advises the use of fire retardant seals. The fire resistance period is the minimum period in minutes.

The extent of the preventive measures depends on the type of installation. The determining of fire areas and fire classification has to be made in acc. with the law of the country. Information is given by the Planning Department and Building Control Office or the Fire Protection Representative.

Basically fire walls and ceilings with pipe passages have to be installed to the same fire resistance classification. All fire protection systems with a corresponding classification are suitable for aquatherm pp-r-pipes.

aquatherm recommends the Rockwool®- Conlit fire retardant seals as ideal solution for both systems. Detailed information about the draft-guidelines 2000 will be given by our technical hotline +49 (0) 2722 950-200 or directly by Rockwool GmbH.

Recommended suppliers

- Deutsche Rockwool Mineralwoll GmbH & Co. OHG
Postfach 207
45952 Gladbeck
Phone: 02043 408-0 · Fax: 02043 408-444
Website: www.rockwool.de
- Doyma GmbH u. Co
Industriestr. 43-57
28876 Oyten
Phone: 04207 9166-0 · Fax: 04207 9166-199
Website: www.doyma.de

APPLICATION OF THE DOYMA CURAFAM® SLEEVE XSPRO FIRE PROTECTION SLEEVE WITH AQUATHERM-PIPE SYSTEMS

Pipe material	Polypropylene
Type of pipe	flammable
Pipe outer diameter	OD ≤ 315mm
Insulation	Sound protection possible; PE-film 3-5 mm, caoutchouc insulation 10-50 mm; with pre-insulated pipes (ti), the insulation on both sides of the component (wall/ceiling) hat to be removed and can be replaced by synthetic caoutchouc in the insulation thickness of 10 – 50 mm.
Fire resistance class	R 90, EI 90
Approval	Z-19.17-1983, ETA-11/0498 APPLICATION OF AQUATHERM-PIPES TESTED POSITIVE, APPROVAL ADD-ON REQUESTED

Dimensions

Pipe OD d (mm)	OD ca. b (mm)	Depth ca. c (mm)	xxx for article number*
1 - 34	43	30	032
35 - 42	56		040
43 - 52	70		050
53 - 65	85		063
66 - 77	99		075
78 - 92	117		090
93 - 112	141		110
113 - 125	154	50	125
126 - 140	178		140
141 - 160	200		160
161 - 180	228		180
181 - 200	253		200
201 - 225	307		225
226 - 250	336		250
251 - 280	370	100	280
231 - 315	410		315

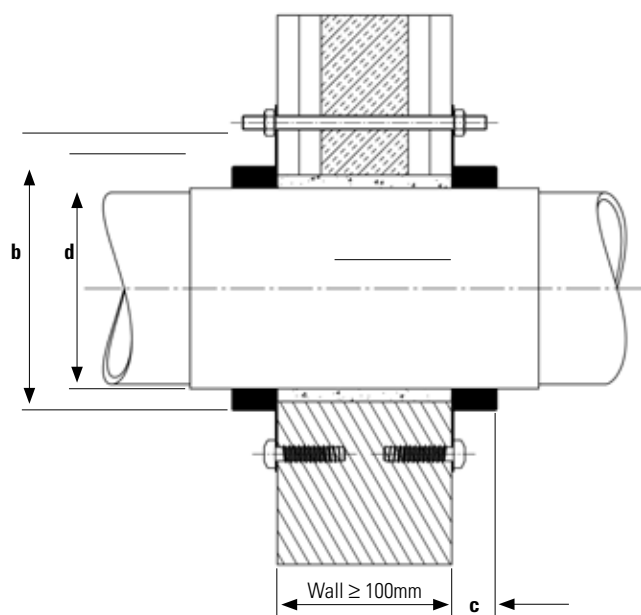

* Article number: 3 22 1 xxx 000 00

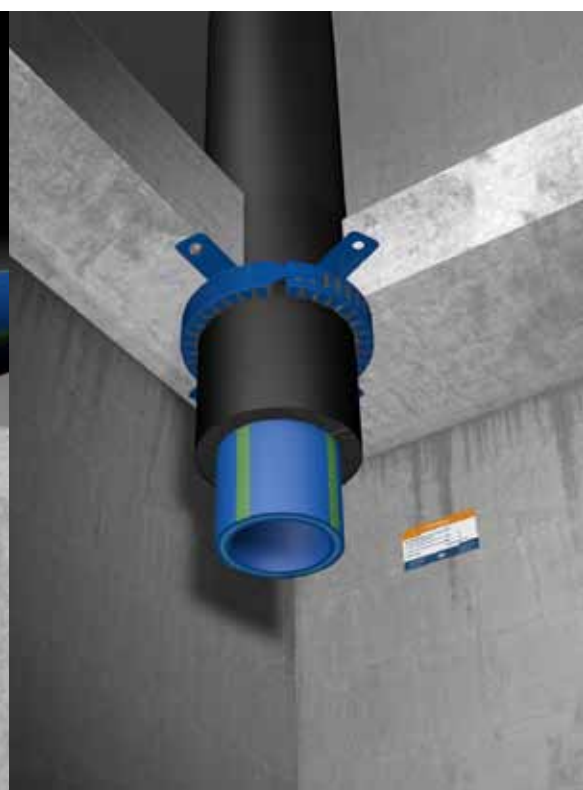
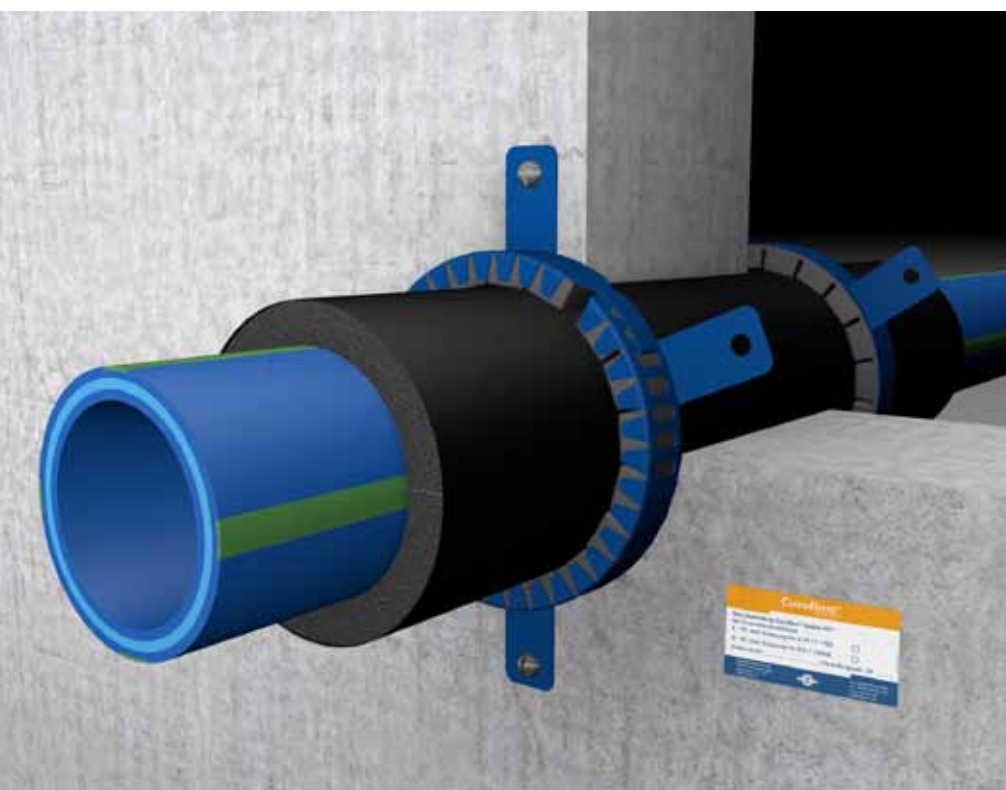

CURAFLAM® SLEEVE XS^{PRO} INSTALLATION EXAMPLES

Solid wall

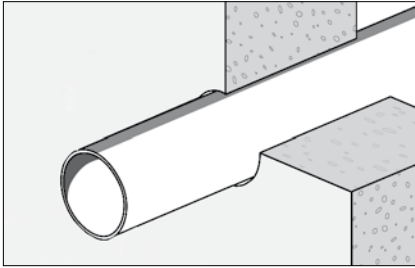

If necessary, wrap the media pipe with a commercial available sound protection film up to 5 mm. Close the remaining opening.

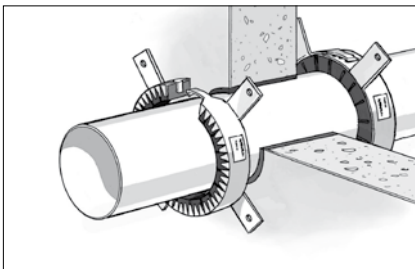

Insert the sleeve around the pipe and seal by closing bracket. Place drillings and plugs suitable to the fixing straps.

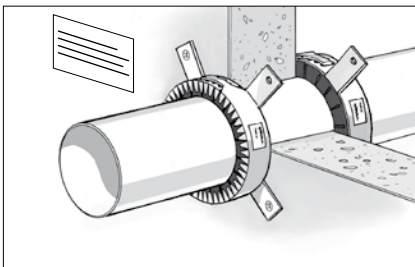

Screw the sleeve with the included fixing set with the ceiling/wall. Label the sign and attach permanently next to the sleeve.

Light partition wall

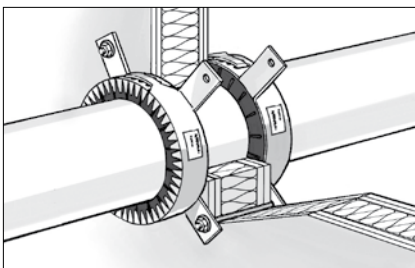

In light partition walls (LPW) the sleeves must be attached opposite with continuous solid threaded rods (M 8).

Ceiling

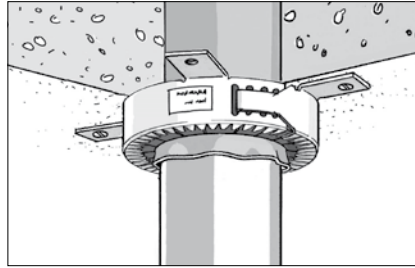

A commercial sound protection film (material PE, up to 5 mm) may be pulled under the sleeve.

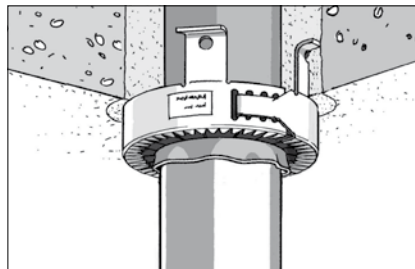

The straps of the sleeve, depending on the pipe type, may be fully gouted in solid ceilings. Then they have to be folded over outwards (see approval).

Special ways

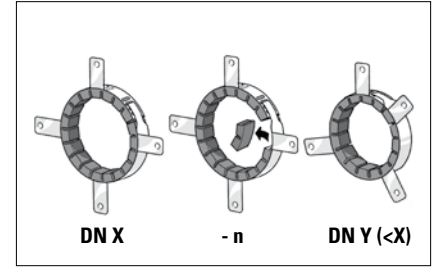

The sleeve-diameter can be reduced by one DN-step. The corresponding number of segments (see table) is to break out at the side of the closing bracket.

Then hook the closing bracket in a tighter interlock opening.

DN X (starting-Ø)	n number of the segments to break out	DN Y (smaller Ø)
DN 32	—	—
DN 40	4	DN 32
DN 50	3	DN 40
DN 63	4	DN 50
DN 75	3	DN 63
DN 90	3	DN 75
DN 110	3	DN 90
DN 125	2	DN 110
DN 140	4	DN 125
DN 160	3	DN 140
DN 180	3	DN 160
DN 200	4	DN 180

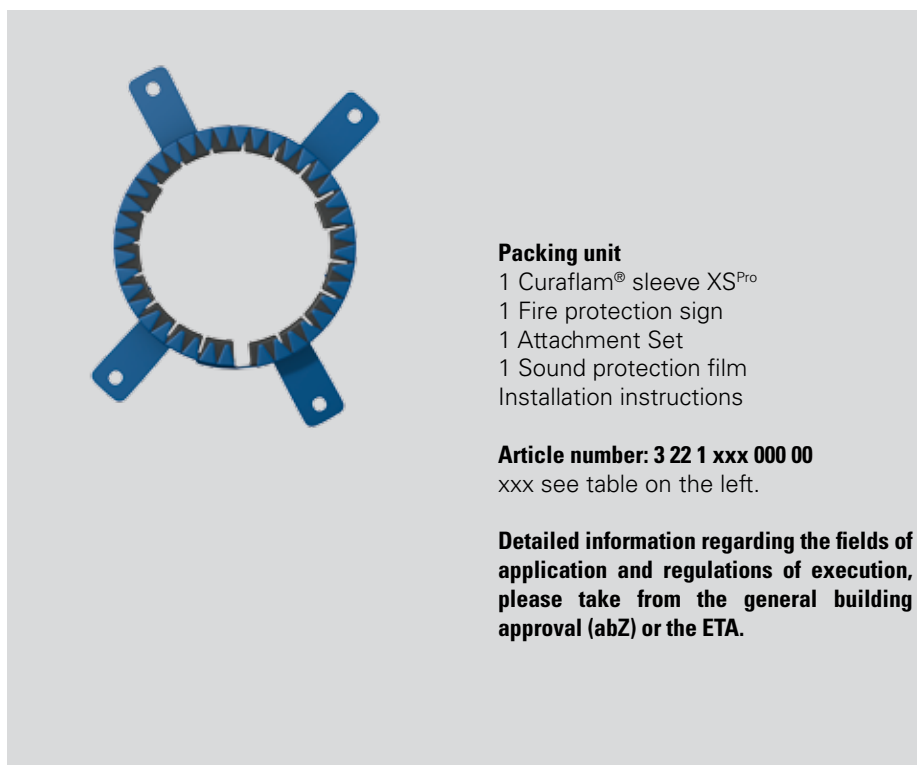

Packing unit

- 1 Curaflam® sleeve XS^{Pro}
- 1 Fire protection sign
- 1 Attachment Set
- 1 Sound protection film
- Installation instructions

Article number: 3 22 1 xxx 000 00

xxx see table on the left.

Detailed information regarding the fields of application and regulations of execution, please take from the general building approval (abZ) or the ETA.

R30 UP TO R 90 PIPE PENETRATIONS FOR THE aquatherm blue pipe INSTALLATION SYSTEM WITH NON-FLAMMABLE MEDIA, SUCH AS HEATING AND COOLING

Material: PP-R
Product name:

aquatherm blue pipe

SDR 7,4 MF
 SDR 11MF
 SDR 7,4 MF UV
 SDR 11 MF UV
 SDR 7,4 MF OT
 SDR 11 MF OT
 SDR 11 S

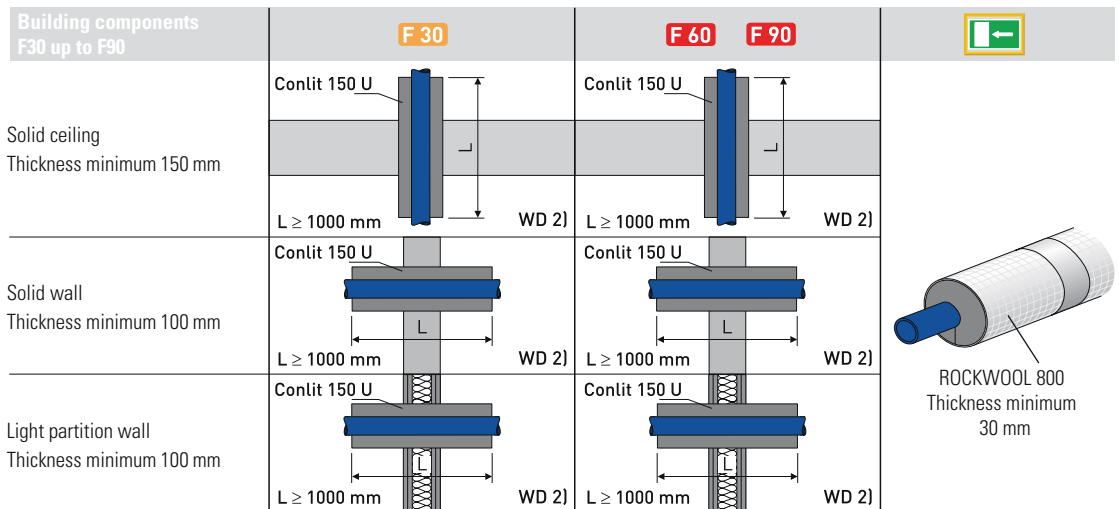

Embodiment according to ROCKWOOL from PP-3726/4140-MPA BS

aquatherm blue pipe	Pipe dimension	Conlit 150 U			ROCKWOOL 800 1) 2) 3)		
	Dimension	Type 3)	Insulation thickness 4) s (mm)	Core drilling Dk (mm)	EnEV 100 % Warm, Type	EnEV 50% Warm, Type	DIN 1988 Cold Type 3)
	20	20/20	20,0	60	22/20	22/20	22/20
25	25/17,5	17,5	60	28/20	28/20	28/20	
32	32/24	24,0	80	35/30	35/20	35/20	
40	40/20	20,0	80	42/40	42/20	42/20	
50	50/25	25,0	100	54/40	54/30	54/30	
63	63/33,5	33,5	130	64/50	64/30	64/30	
75	75/52,5	52,5	180	76/70	76/40	76/30	
90	90/65	65,0	220	102/80	102/40	102/30	
110	110/70	70,0	250	114/100	114/50	114/30	

Notes / Special installation conditions

- 1) In some cases, the available minimum insulation thickness is specified
- 2) The insulation jacket ROCKWOOL 800 can be used as further insulation
- 3) According to DIN 1988-200 there must be a vapor barrier, so only use fire protection jacket Conlit 150U/ insulation jacket ROCKWOOL 800
- 4) Insulation thickness according to EnEV 50 % and DIN 1988-200 fitting to the core hole diameter Dk

All constraints of the specific general building inspection certificates (abP) must be considered.

FIRE LOAD

The values required for determining the fire load within a fire section are calculated from the total of all flammable materials located within this area.

The calculation for establishing the combustion heat V [kWh/m] for a fire section in the event of an outbreak is dependent on dimensions and materials.

The basis used for the calculation of pipes made of PP-R is the lower calorific value $H_u = 12.2$ kWh/kg (as per DIN V 18230 T1) in conjunction with the mass of material m_{pipe} [kg/m].

The integrated layers of fiber-composite pipes also are considered.

Depending on the calculation procedure, the fire load is worked out with reference to the burn-up factor. This value is designated as m_{factor} and is taken as 0.8 for polypropylene.

Combustion values V [kWh/m] for aquatherm blue pipe

Dimension mm	aquatherm blue pipe SDR 7,4 MF/OT	aquatherm blue pipe SDR 11 MF/OT	aquatherm blue pipe SDR 17,6 MF
20	1,76	-	-
25	2,74	-	-
32	4,39	3,14	-
40	-	4,83	-
50	-	7,48	-
63	-	11,82	-
75	-	16,48	-
90	-	23,86	-
110	-	35,33	-
125	-	45,83	30,03
160	-	74,88	48,53
200	-	116,64	75,68
250	-	181,42	117,64
315	-	285,82	186,32
355	-	362,93	236,07
400	-	460,78	299,73
450	-	583,21	378,64
500	-	-	468,24
560	-	-	584,88
630	-	-	740,59

COMPLIANCE WITH THE SYSTEM STANDARD

Various national and international independent authorities and institutions confirm aquatherm’s quality standard



AQUATHERM QUALITY MANAGEMENT SYSTEM

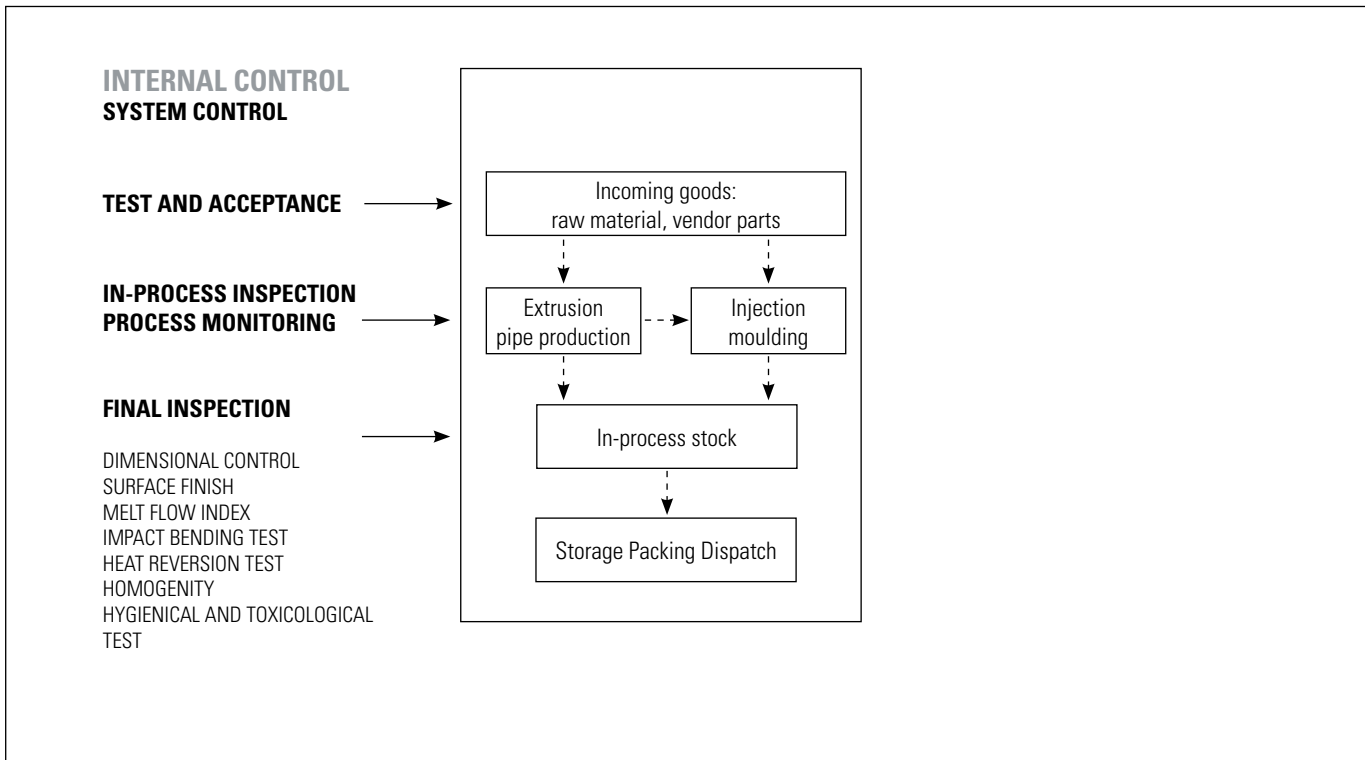

In addition to the permanent internal quality control, an external control is made by i.e. SKZ, SAI, TGM, Hygieneinstitut.



SYSTEM CONTROL

The production of a quality controlled pipe system demands the supervision, regulation and control of all work operations. All results and processes have to be documented.

This requires

test and acceptance of incoming goods
process control
in-process inspection and test
final inspection and test

Relevant regulations for the quality control of potable water pipe systems are:

DIN- guidelines
 DVGW- working sheets
 Supervisory Regulations of the SKZ
 (Süddeutsches Kunststoff- Zentrum)

These standards and guidelines detail the minimum requirements for internal control.

Conformance to the standards is verified by independent institutes in form of internal audits and laboratory tests.

aquatherm has many years of experience in extrusion and injection moulding and is the market leader and pioneer in the manufacture of polypropylene pipe systems.

This experience is reflected in internal quality standards and laid down procedures, which are taken strongest note of and are documented by the constant quality of our products.

INTERNAL CONTROL

Trained and qualified employees and a modern equipped laboratory ensure that all tests are carried out and regulations are complied with in accordance with the quality control policy, which includes

control of inspection, measuring and test equipment process and production control
receiving inspection test
in-process inspection
final inspection

All internal quality controls are documented and recorded in acc. with the quality control policy.



QUALITY ASSURANCE

Test and acceptance of incoming goods

All incoming goods are subject to a test. This ensures that incoming products conform to specified requirements. Goods, which have not been tested are not released for production.

In-process inspection and test

The quality plan requires that tests and inspections are carried out before and during production. At the start of production all quality relevant data are checked by the quality assurance department. Preproduction samples are tested by the laboratory technicians for

- surface finish
- dimensional accuracy of the test samples
- data from extrusion and injection moulding machines

The goods will be released for production only if optimal test results are achieved. These tests are carried out at the beginning of each production series to ensure perfect system quality.

Process control

Ultrasonic measurement and process data recording in the field of extrusion are only one example of the extensive quality control process.

This equipment enables constant observation and control of production.

Ultrasonics automatically measure and report any deviations in tolerance to the cutting device on the extrusion machine so that the sizing plant automatically isolates a substandard product. This ensures that only perfect quality products are packed and stored.

All data received during production is analyzed in detail.

Final inspection and test

The quality plan requires that inspections and tests are carried out on all finished products. The results are documented in test reports. Finished products are only released to stock when all tests and inspections conform to the prescribed procedures and specifications.

The final inspection and test includes time lapse test procedures. This enables statements regarding the usability of the products in their later field of application.

These tests are the method for quality assurance during production and for design tests. This is to discover and remove production weaknesses. The results document the system quality and optimize the manufacturing processes. The final inspection and test covers the following test procedures:

- Dimensional control
- Surface finish
- Measurement of the melt flow index
- Impact bending test
- Heat reversion test
- Homogeneity of the material
- Internal pressure test

In addition to the tests mentioned above, daily hygiene tests in accordance with KTW/DVGW Guidelines are carried out regularly in the company's own sensory analysis laboratory.



EXTERNAL CONTROL

External supervision consists of tests of a defined scope and in defined intervals. The respective supervising institutions appoint authorized test organizations to carry out these tests.

The external supervision includes external tests of the products and

- a) internal audit of aquatherm's quality assurance system and test procedures,
- b) calibration of the test equipment and
- c) hygienic and toxicity tests.

The results of the supervisory visits as well as external tests made on pipe and fitting samples are confirmed to aquatherm in test certificates.

In Germany, the external supervision of the aquatherm pipe system is carried out by the

- SKZ (Süddeutsches Kunststoffzentrum Würzburg)
- Institute for Hygiene, Gelsenkirchen (Hygieneinstitut Gelsenkirchen)

who are authorized by the DVGW (German Institute for Gas and Water) as controlling organization. The external supervision for certificates from abroad is carried out in a similar way.

Storage / packing / dispatch

Upon successful release the products are stored in suitable warehouses.

Internal instructions control the method of packing, storage and dispatch of the products. The warehouse staff is responsible for control of the stored product.

PERMISSIBLE WORKING PRESSURE

For heating systems or closed systems considering the seasonal periods of operation - non potable water application

Heating period	Temperature	Service life	aquatherm blue pipe SDR 11 MF, OT & S		aquatherm blue pipe SDR 17,6 MF	
			Permissible working pressure in bar and (psi)			
			bar	(psi)	bar	(psi)
constant operating temperature 70 °C / 158 °F incl. 30 days per year at	75 °C	5	9,38	(136)	5,38	(78)
		10	9,08	(132)	5,21	(76)
		25	7,82	(113)	4,48	(65)
		45	6,77	(98)	3,89	(56)
	80 °C	5	8,88	(129)	5,09	(74)
		10	8,46	(123)	4,86	(70)
		25	7,38	(107)	4,24	(61)
	85 °C	5	8,17	(118)	4,69	(68)
		10	7,82	(113)	4,49	(65)
		25	6,70	(97)	3,85	(56)
		37,5	6,07	(88)	3,49	(51)
	90 °C	5	7,50	(109)	4,30	(62)
10		7,19	(104)	4,13	(60)	
25		5,85	(85)	3,36	(49)	
35		5,39	(78)	3,09	(45)	
constant operating temperature 70 °C / 158 °F incl. 60 days per year at	75 °C	5	9,26	(134)	5,31	(77)
		10	8,90	(129)	5,11	(74)
		25	7,62	(111)	4,37	(63)
		45	6,60	(96)	3,79	(55)
	80 °C	5	8,61	(125)	4,94	(72)
		10	8,24	(120)	4,73	(69)
		25	6,93	(101)	3,98	(58)
	85 °C	5	7,91	(115)	4,54	(66)
		10	7,56	(110)	4,34	(63)
		25	6,05	(88)	3,47	(50)
		35	5,57	(81)	3,20	(46)
	90 °C	5	7,25	(105)	4,16	(60)
10		6,40	(93)	3,67	(53)	
25		5,12	(74)	2,94	(43)	
constant operating temperature 70 °C / 158 °F incl. 90 days per year at	75 °C	5	9,17	(133)	5,26	(76)
		10	8,79	(127)	5,04	(73)
		25	7,45	(108)	4,27	(62)
		45	6,45	(94)	3,70	(54)
	80 °C	5	8,46	(123)	4,85	(70)
		10	8,11	(118)	4,65	(67)
		25	6,60	(96)	3,78	(55)
	85 °C	5	7,76	(113)	4,45	(65)
		10	7,03	(102)	4,04	(59)
		25	5,63	(82)	3,23	(47)
		32,5	5,28	(77)	3,03	(44)
	90 °C	5	6,96	(101)	3,99	(58)
10		5,88	(85)	3,37	(49)	
25		4,70	(68)	2,70	(39)	

* SDR = Standard Dimension Ratio (diameter/wall thickness ratio)
SDR = 2 x S + 1 ≈ d/s (S = Pipe series index from ISO 4065)

PERMISSIBLE WORKING PRESSURE

for general pressure pipe applications in permanent operation
charted application ranges on the left

Temperature	Service life	aquatherm blue pipe SDR 17,6 MF		aquatherm blue pipe SDR 11 MF & MF OT	
		Permissible working pressure in bar and (psi)			
		bar	(psi)	bar	(psi)
10 °C	1	12,8	(186)	27,8	(403)
	5	12,0	(174)	26,2	(380)
	10	11,7	(170)	25,6	(371)
	25	11,4	(165)	24,7	(358)
	50	11,1	(161)	24,1	(350)
15 °C	100	10,8	(157)	23,5	(341)
	1	11,8	(171)	25,7	(373)
	5	11,1	(161)	24,2	(351)
	10	10,8	(157)	23,6	(342)
	25	10,5	(152)	22,8	(331)
20 °C	50	10,2	(148)	22,2	(322)
	100	9,9	(144)	21,6	(313)
	1	10,9	(158)	23,8	(345)
	5	10,3	(149)	22,3	(323)
	10	10,0	(145)	21,7	(315)
30 °C	25	9,6	(139)	21,0	(305)
	50	9,4	(136)	20,4	(296)
	100	9,1	(132)	19,9	(289)
	1	9,3	(135)	20,2	(293)
	5	8,7	(126)	18,9	(274)
40 °C	10	8,5	(123)	18,4	(267)
	25	8,2	(119)	17,8	(258)
	50	7,9	(115)	17,3	(251)
	100	7,7	(112)	16,8	(244)
	1	7,9	(115)	17,1	(248)
50 °C	5	7,4	(107)	16,0	(232)
	10	7,2	(104)	15,6	(226)
	25	6,9	(100)	15,0	(218)
	50	6,7	(97)	14,6	(212)
	100	6,5	(94)	14,1	(205)
60 °C	1	6,7	(97)	14,5	(210)
	5	6,2	(90)	13,5	(196)
	10	6,0	(87)	13,1	(190)
	25	5,8	(84)	12,6	(183)
	50	5,6	(81)	12,2	(177)
70 °C	100	5,5	(80)	11,9	(173)
	1	5,6	(81)	12,2	(177)
	5	5,2	(75)	11,4	(165)
	10	5,1	(74)	11,0	(160)
	25	4,9	(71)	10,6	(154)
75 °C	50	4,7	(68)	10,3	(149)
	1	4,7	(68)	10,3	(149)
	5	4,4	(64)	9,6	(139)
	10	4,2	(61)	9,2	(133)
	25	3,7	(54)	8,0	(116)
80 °C	50	3,1	(45)	6,8	(99)
	1	4,3	(62)	9,4	(136)
	5	4,0	(58)	8,7	(126)
	10	3,7	(54)	8,0	(116)
	25	3,0	(44)	6,4	(93)
85 °C	50	2,5	(36)	5,4	(78)
	1	4,0	(58)	8,6	(125)
	5	3,5	(51)	7,7	(112)
	10	3,0	(44)	6,5	(94)
	25	2,4	(35)	5,2	(75)
90 °C	1	3,3	(48)	7,2	(104)
	5	2,3	(33)	5,1	(74)
	10	2,0	(29)	4,3	(62)

SDR = Standard Dimension Ratio (diameter/wall thickness ratio)
MF = multilayer faser

For fittings of butt-welded pipe segments a reduction factor of 0.75 (reduction of the table values by 25%) is effective.

CONNECTION

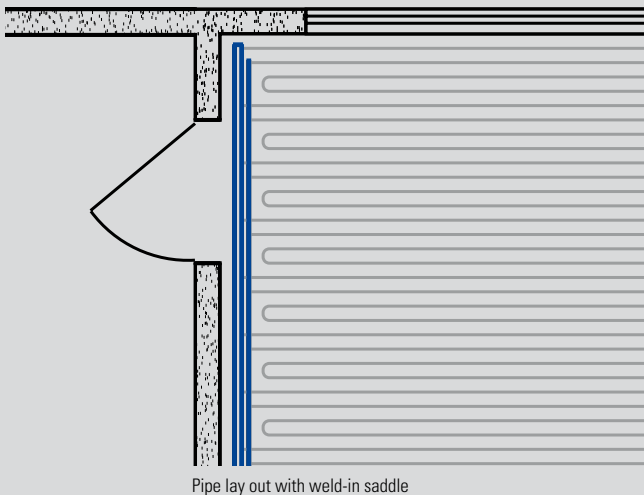

Pipe lay out with weld-in saddle



REVERSE RETURN TECHNIQUE (Tichelmann-principle)

The weld-in saddle technique, developed by aquatherm orange system provides the connection of the heating pipes to a continuous manifold pipe acc. to reverse return. This technique is applied for the double swing floor design a+b and industrial floor heating.

On applying the reverse return technique all heating circuits have the same length. Thus the pipe lay out ensures the same pressure loss for all heating circuits. A hydraulic balancing of the heating circuits is not required.

Installation

For this connection technique the manifold pipes are made from aquatherm blue pipe or faser composite pipes and weld-in saddles. The spacing of saddles is determined by the pipe spacing of the heating pipes. aquatherm grey pipe transition adapter are applied for the connection of the oxygen-tight heating pipes. They provide an optimum connection between the aquatherm blue pipe or faser composite pipes and the aquatherm orange system.

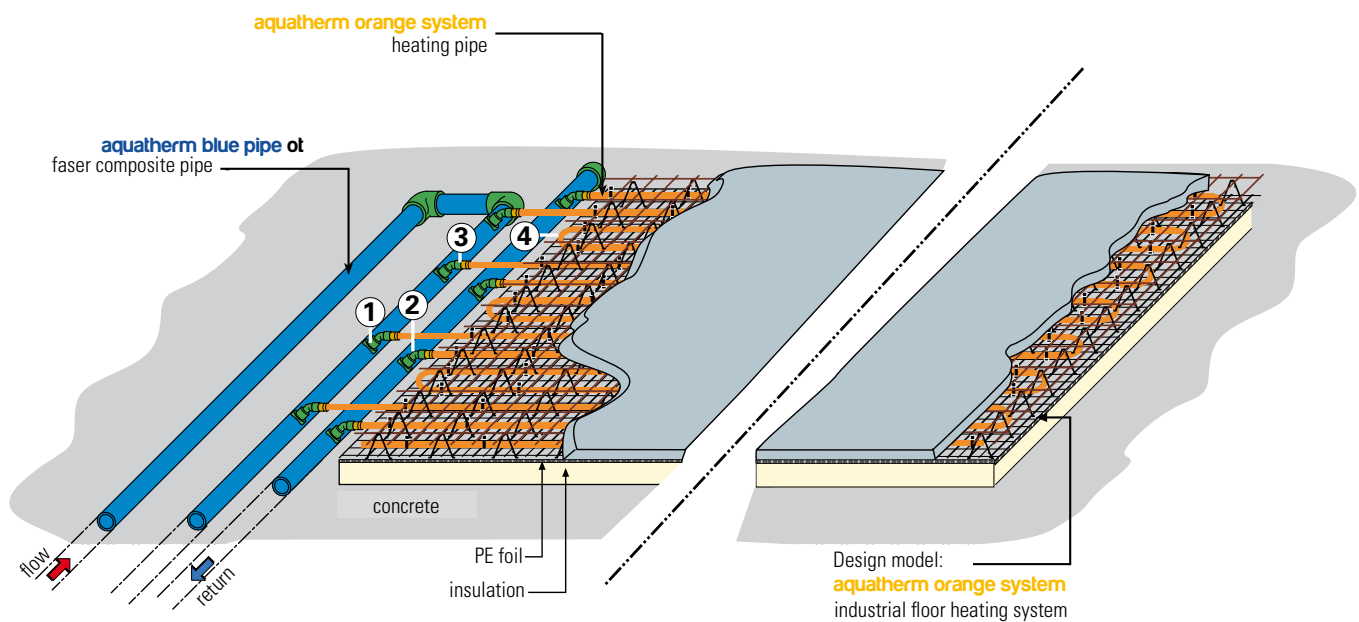

1. aquatherm green pipe-weld-in saddle

3. aquatherm grey pipe-transition adapter

2. aquatherm green pipe-elbow 45°

4. heating pipe



UNDER SOIL HEATING

To keep a pitch with natural or artificial turf or any other open area free from ice and snow aquatherm offers a system to provide an under soil heating efficiently and in consideration of environmental aspects.

The ideal combination of aquatherm blue pipe and aquatherm green pipe compounds creates this condition.





ICE SURFACE COOLING

The ice surface cooling system is made of an ideal combination of aquatherm blue pipe and and aquatherm green pipe-components. For the construction of mobile ice rink surfaces the pipework is completed with aquatherm blue pipe components.

The distribution pipes as well as the manifold connecting pipes are made from aquatherm blue pipes and connected by reverse return (Tichelmann-principle). The weld-in saddle technique, developed by aquatherm, is applied for the production of manifold branches.





INDUSTRIAL FLOOR HEATING

Fields of application

- Production halls
- Workshops
- Warehouses
- Logistics centers
- Maintenance hangars
- Exhibition halls
- Market halls
- Salesrooms
- Cold storage warehouses with sub-freezing protection heater

Industrial buildings are planned by builders and architects in a way that preferably the entire volume of space is utilized.

TGA-installation must not impede the working processes. With component integrated surface heating systems the entire surface area is available to the user. That creates absolute space freedom and optimal utilization of the halls. An industrial surface heating provides a uniform temperature profile, low air speeds, has no maintenance costs, works with lowest temperatures and has a fast pay back.

The lifetime of the pipes corresponds to the life of the building!

Energy efficiency

Systems near to room temperature have the highest energy efficiency. Large transfer surfaces are required for the operation of heat pumps and the use of waste heat. Only industrial surface heating is suitable for these requirements.

Thermal insulation

Thermal insulation in industrial surface heating is usually placed under the concrete slab as perimeter insulation (adjacent to ground).

Depending on the static load it is chosen between extruder foam and foam glass plates. The insulation material for the perimeter insulation must be impervious to moisture and suitable for the loads occurring.

In calculating the U-value, according to DIN 4108, only layers up to the building sealing have to be included. Only when presenting a building approval for the selected building material the insulation value of the perimeter insulation can be included in the calculation of the U-value for the entire construction.

Construction types of floor slabs

Heating pipes can be integrated in the following types of concrete:

- Reinforced concrete with bottom reinforcement
- Reinforced concrete with bottom and top reinforcement
- Steel fiber concrete without reinforcement mats

Surface treatments (such as in vacuum concrete) are easily possible.

Construction types of industrial surface heating according to pipe fixing

Option A: Matt reinforced concrete, fixing of heating pipes by spring rails on the bottom reinforcement

Option B: Matt reinforced concrete, fixing of heating pipes by cable ties at the bottom reinforcement

Option C: steel fiber concrete, fixing of heating pipes by spring rail on the film

Also, industrial surface heating must be subjected to a leak test. The pressure test is performed immediately prior to the concreting process. The test pressure of the water pressure test is at least 4 bar and not more than 6 bar. This pressure is to be kept during the concreting process.

The leak test must be documented. The test record is used as a confirmation for the architect and the constructor.

Concreting

The concrete is placed in a ready-mixed consistency with the transport hose, distributed, levelled and compacted.

Functional heating

Also industrial surface heating has to be heated up after the placement of the concrete and top layer (functional heating). The earliest possible start of heating is dependent on the quality and thickness of the concrete and must be agreed with the concrete layer/structural engineer. The wait time is usually 28 days. The functional heating is simply a function test according to VOB DIN 18380.



HEATING AND AIR-CONDITIONING

aquatherm blue pipe includes all pipe installation components for chilled water, hot and various industrial applications. Reduced wall thickness offers higher flow rates and the products are stabilised under heat.





SHIPBUILDING

Corrosion resistance against aggressive media and sea water with low ph-values makes aquatherm blue pipe the ideal pipe system in shipbuilding.

A major advantage of the saltwater resistant pipe systems is the fast processing and repair works easy to be carried out, even on sea.



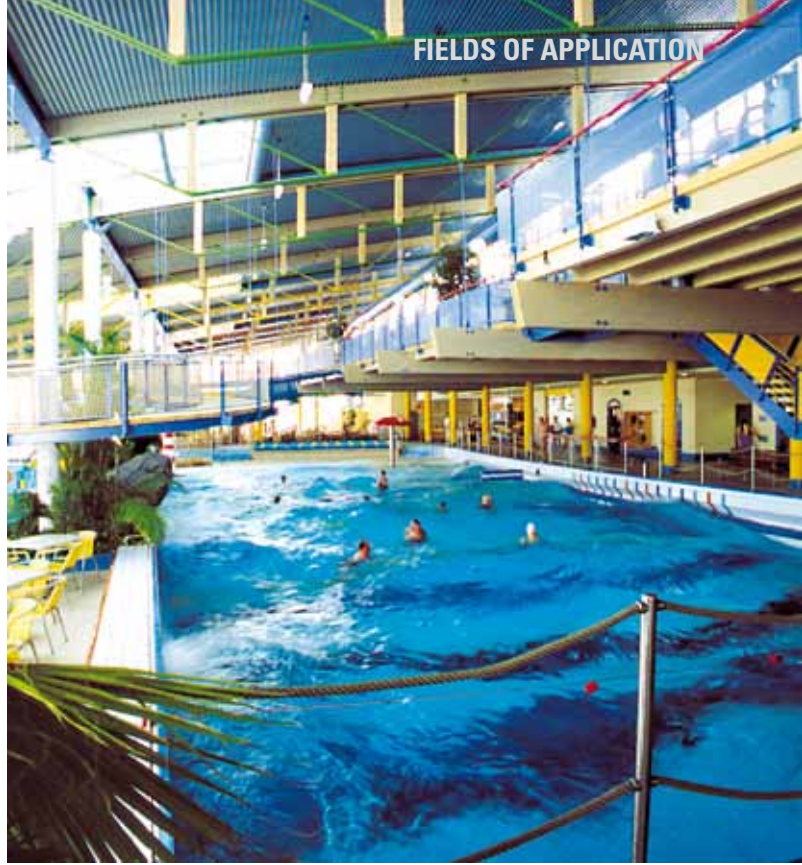

COMPRESSED AIR

The aquatherm blue pipe system is also suitable for the use of industrial compressed air systems. Whether indoor, outdoor or even in the underground area, our blue pipes are suitable for pressure air everywhere. The lower weight, compared to metal pipes is an advantage in e.g. compressed air pipe systems mounted under hall roofs with high altitudes. Additionally, the material PP-R is also resistant to non-treated oil-contaminated compressed air.

SWIMMING POOL

For the pool operator only pure water guarantees the safety to offer its guests unlimited swimming pleasure. Only a working heating gives him the assurance of a smooth, low-loss operation, preferably for 52 weeks of the year.

The pipe systems made by aquatherm offer both, in the field of water management as well as in the associated heating technology, a complete and reliable all-round supply on the foundation of a more than 40-year experience.





AGRICULTURE

In the agricultural sector, the possible applications of the aquatherm blue pipe system are manifold. The system can be used not only for the climatisation of cattle sheds, but also for the transport of disinfectants in the professional shed cleaning, to improve the hygiene and health of the animals and thus, e.g. milk quality.

Furthermore, the system is suitable for the field and green area irrigation or transportation of fertilizers in gardening and landscaping.

SPECIAL APPLICATIONS

EXAMPLE: SKI JUMPS

To save the state of the track on the so-called ski jump start of a ski-jump even in changing weather conditions, and thus secure equality of opportunity in the start-up speed, aquatherm-cooling grids are installed immediately below the in-run. These are fed by a glycol-water mixture running through the aquatherm blue pipes and thus the track is cooled evenly and consistently.

The ski jump is just one example of the many special applications of the aquatherm blue pipe system.





aquatherm blue pipe

Flange connections and transition joints enable the connection of all components to the central heating system and on the floor.



Risers and distribution piping for heating supply should be planned and installed with aquatherm blue pipe - fiber composite pipes.

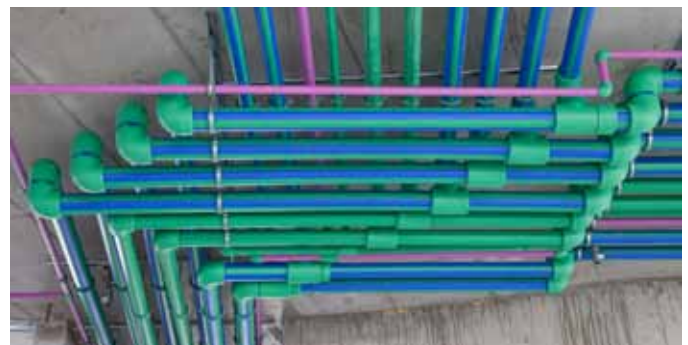

The connection of floor heating systems or the installation of radiator pipes up to the manifold can also be carried out with aquatherm blue pipe.



PART A: ASSEMBLY OF WELDING TOOLS

The professional processing of aquatherm PP-R - medium pipes is made by the following tools for the connection of insulated pipes and fittings by socket welding or by butt-welding.

IMPORTANT!

Only use the original aquatherm welding devices and aquatherm welding tools, except devices and tools which are especially approved by aquatherm.

1. **aquatherm** - manual welding device (800 W) without welding tools (Art.-No. 50337) for medium pipes of dimension 16 – 63 mm
2. **aquatherm** - manual welding device (1400W) without welding tools (Art.-No. 50341) for medium pipes of dimension 50 – 125 mm
3. **aquatherm** - welding tools for manual welding devices

Art.-No. 50208	20 mm
Art.-No. 50210	25 mm
Art.-No. 50212	32 mm
Art.-No. 50214	40 mm
Art.-No. 50216	50 mm
Art.-No. 50218	63 mm
Art.-No. 50220	75 mm
Art.-No. 50222	90 mm
Art.-No. 50224	110 mm
Art.-No. 50226	125 mm

4. **aquatherm** welding machine (1400W) incl. welding tools 50 – 125 mm (Art.-No. 50148) for medium pipes of dimension 50 – 125 mm
5. **aquatherm** - butt-welding-machines for medium pipes of dimension 160 – 630 mm
6. **aquatherm** - electrical welding jig Art.-No. 50159 for medium pipes of dimension 63 -125 mm



Manual welding device 800W with welding tools 16 – 63 mm



Manual welding device 1400W with welding tools 50 – 125 mm

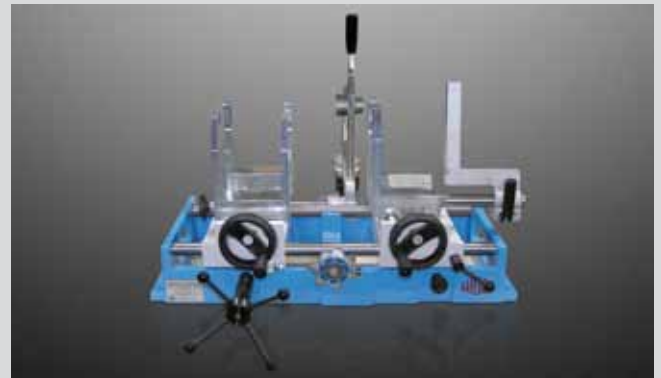

Welding machine



Butt-welding machine type Light and accessories



Electrical welding jig

MOUNTING OF THE TOOLS

1. aquatherm green, blue and lilac pipe system are processed identically.

Assemble and tighten the cold welding tools manually.

3. Before fusing the distribution block, in which two connections are fused simultaneously, the welding tools have to be placed into the respective holes as described in the adjoining table A and drawing B.

4. All welding tools must be free from impurities. Check if they are clean before assembling. If necessary clean the welding tools with a non fibrous, coarse tissue and with methylated spirit.

5. Place the welding tools on the welding device so that there is full surface contact between the welding tool and the heating plate. Welding tools over $\varnothing 40$ mm must always be fitted to the rear position of the heating plate.

Electric supply:

The power supply must coincide with the data on the type plate of the welding device and must be protected according to the local regulations. To avoid high power loss, the conductor cross-section of the used extension cables must be selected according to the power input of the welding devices.

6. Plug in the welding device. Depending on the ambient temperature it takes 10-30 minutes to heat up the heating plate.

A

Art.-No.	Passage	Hole	Branch	Hole
30115	$\varnothing 25$ mm	A + E	$\varnothing 20$ mm	A + C
85123	$\varnothing 20$ mm	A + B	$\varnothing 16$ mm	A + C
85124	$\varnothing 20$ mm	A + B	$\varnothing 16$ mm	A + C

B

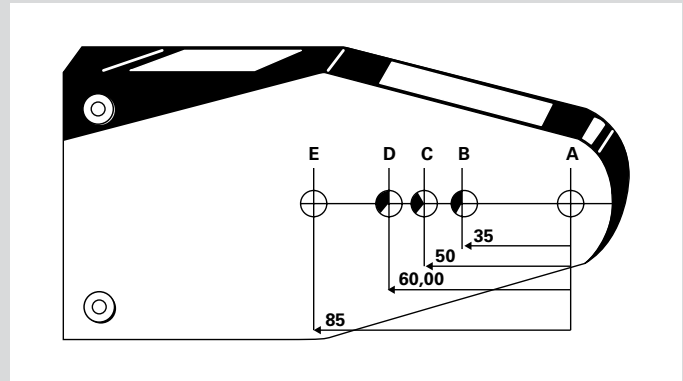

PART A: HEATING UP PHASE / HANDLING



Part A: Heating up phase

7. During the heating up phase tighten the welding tools carefully with the Allan key.

Take care that the tools completely contact the heating plate. Never use pliers or any other unsuitable tools, as this will damage the coating of the welding tools.

8. The temperature of 260° C is required for the welding of aquatherm PP-R pipes.

Acc. to DVS-Welding Guidelines the temperature of the welding device has to be checked at its tool before starting the welding process.

This can be done with a fast indicating surface thermometer.

ATTENTION:

First welding - soonest 5 minutes after reaching of the welding temperature. DVS 2207, Part 11.

Part A: Handling

9. A tool change on a heated device requires another check of the welding temperature at the new tool (after its heating up).

10. If the device has been unplugged, e.g. during longer breaks, the heating up process, has to be restarted (see item 6).

11. After use unplug the welding device and let it cool down. Water must never be used to cool the welding device, as this would destroy the heating resistances.

12. Protect aquatherm-welding devices and tools against impurities. Burnt particles may lead to an incorrect fusion. The tools may be cleaned with aquatherm-cleaning cloths, Art.-No.50193.

Always keep the welding tools dry.

13. After welding, do not lay the the device on the Teflon coated tool, but put it down in the provided supporting stand.

14. For a perfect fusion, damaged or dirty welding tools must be replaced, as only impeccable tools guarantee a perfect connection.

15. Never attempt to open or repair a defective device. Return the defective device for repair.

16. Check the operating temperature of aquatherm-welding devices regularly by means of suitable measuring instruments.

PART A: GUIDELINES
PART B: CHECKING OF DEVICES AND TOOLS

Part A: Guidelines

17. For the correct handling of welding machines the following must be observed:

General Regulations for Protection of Labour and Prevention of Accidents and particularly the Regulations of the Employers' Liability Insurance Association of the Chemical Industry regarding Machines for the Processing of Plastics, chapter: „Welding Machines and Welding Equipment“.

18. For the handling of aquatherm-welding machines, devices and tools please observe General Regulations DVS 2208 Part 1 of the German Association for Welding Engineering, Registered Society (Deutscher Verband für Schweißtechnik e. V.).

Part B: Checking of devices and tools

1. Check, if the aquatherm-welding devices and tools comply with to the guidelines "Fusion Part A".

2. All used devices and tools must have reached the necessary operating temperature of 260 °C. This requires acc. to "Fusion Part A, item 8" a separate test, which is indispensable (DVS - Welding Guidelines):

Suitable measuring instruments have to measure a temperature of up to 350° C with a high accuracy.

NOTE:

aquatherm recommends the original aquatherm temperature measuring device art.-no. 50188

PART B: PREPARATION FOR THE FUSION

3. Cut the pipe at right angles to the pipe axis. Only use aquatherm pipe cutters or other suitable cutting pliers. Take care that the pipe axis is free from burrs or cutting debris and remove where necessary.

4. Mark the welding depth at the end of the pipe with the enclosed pencil and template.

5. Mark the desired position of the fitting on the pipe and / or fitting. The markings on the fitting and the uninterrupted line on the pipe may be used as a guide.



Measurement of temperature at the aquatherm manual welding device (800W)



Measurement of temperature at the aquatherm welding machine



Measurement of temperature at the aquatherm butt-welding machine



Cutting of the pipe



Marking of the welding depth

PART B: HEATING OF PIPE AND FITTING

Heating of pipe and fitting

6. Push the end of the pipe, without turning, up to the marked welding depth into the welding tool.

It is essential to observe the above mentioned heating times.

Pipes and fittings of the dimensions Ø 75 to 125 mm can only be welded with welding device Art.-No. 50341 (or with machine Art.-No. 50148). On using the aquatherm-welding machine Art.-No. 50148 a separate operating instruction has to be observed.

ATTENTION:

The heating time starts, when pipe and fitting have been pushed to the correct welding depth on the welding tool. Not before!

PART B: SETTING AND ALIGNMENT

7. After the required heating time quickly remove pipe and fitting from the welding tools. Joint them immediately, and without turning, until the marked welding depth is covered by the PP-bead from the fitting.

ATTENTION:

Do not push the pipe too far into the fitting, as this would reduce the bore and in an extreme case will close the pipe.

8. The joint elements have to be fixed during the specified assembly time. Use this time to correct the connection. Correction is restricted to the alignment of pipe and fitting. Never turn the elements or align the connection after the processing time.

9. After the required cooling time the fused joint is ready for use.

The result of the fusion of pipe and fitting is a permanent material joining of the system elements. Connection technique with security for a life-time.

The fusion is subject to the following data

Pipe external-Ø	Welding depth	Heating time		Welding time	Cooling time
		sec. DVS	sec. AQE*		
mm	mm			sec.	min.
20	14,5	5	8	4	2
25	16,0	7	11	4	2
32	18,0	8	12	6	4
40	20,5	12	18	6	4
50	23,5	18	27	6	4
63	27,5	24	36	8	6
75	30,0	30	45	8	8
90	33,0	40	60	8	8
110	37,0	50	75	10	8
125	40,0	60	90	10	8



Heating-up of pipe and fitting



Joining, fixing and...



...aligning



The result: a permanent connection!

*heating times recommended by aquatherm at ambient temperatures below + 5 °C

Dimension 160 - 630 mm:

The dimension 160 - 630 mm are joined by butt-welding.

Detailed information page 64 + 65.

The General Guidelines for Heated Tool Socket Welding acc. to DVS 2207 Part 11 are applied hereupon.

PART B: PREPARATION FOR THE FUSION

By using the aquatherm universal peeling tools the end pieces of the aquatherm blue pipe OT and UV can be peeled. By the uniform removal of the outer layer of the pipe any extension of the pipe system by electrofusion socket or fitting is possible. The universal peeling tools are available in the sizes $\varnothing 20$ - $\varnothing 125$ mm (Art.-No. 50479 – 50488). The peeling process is done either mechanically or manually. For the mechanical processing two attachment plates for pipe sizes $\varnothing 20$ - $\varnothing 63$ mm (Art.-No. 50499) and $\varnothing 75$ - $\varnothing 125$ mm (Art.-No. 50500) are available. For the mechanically processing of the electrofusion sockets the peeler is extended by an attachment (Art.-No. 50489 – 50498). The power drill should have a high torque.

1. INSTRUCTIONS FOR THE MECHANICAL PEELING PROCESS

1.1. The attachment plate is clamped with the hexagon bolt in the power drill.

1.2. The peeler is fixed with its screws in the slot matching the diameter of the attachment plate and rotated clockwise so that the peeler adheres to the attachment plate.

1.3. The peeling tool clamped on the chuck is set by the lead to the end of the pipe.

1.4. The peeling process starts with rotation of the peeling tool upon slight force in axial direction. The peeling operation is completed when the attachment plate strikes against the pipe end.

1.5. The pipe now can be welded by socket welding method.

2. INSTRUCTIONS FOR THE MECHANICAL PEELING PROCESS FOR ELECTROFUSION SOCKETS

2.1. The extension is centered with the peeler through the superimposed chamfer fit and fastened with three Allen screws.

2.2. The attachment plate is clamped with the hexagon bolt in the power drill and connected with the peeling tool (see photo **1.2.**).

2.3. The peeling process starts with rotation of the peeling tool upon slight force in axial direction. The peeling operation is completed when the carrier plate strikes against the pipe end.

2.4. The peeling tool is withdrawn from the pipe and the E-socket welding process can start.

3. PEELING INSTRUCTIONS FOR MANUAL PEELING

3.1. For the manual peeling two handles are mounted at the peeling tool.

3.2. The peeling tool is pushed onto the untreated pipe up to the stop.

3.3. The peeling tool is turned clockwise as long as the marked peeling depth (see table) is reached.

3.4. If the specified/marked peeling depth (see table) is reached, the peeling tool is removed and the socket welding process can start. If the electric socket can be used as a sliding sleeve, the peeling depth for the electric socket welding (see table) must be doubled.





**TABLE OF PEELING DEPTH:
SOCKET AND ELECTRIC SOCKET WELDING**

Diameter	Peeling depth Socket welding	Peeling depth Electric socket welding
ø 20	16 mm	39 mm
ø 25	20 mm	43 mm
ø 32	22 mm	45 mm
ø 40	25 mm	50 mm
ø 50	28 mm	56 mm

Diameter	Peeling depth Socket welding	Peeling depth Electric socket welding
ø 63	32 mm	65 mm
ø 75	34 mm	69 mm
ø 90	37 mm	77 mm
ø 110	42 mm	85 mm
ø 125	44 mm	90 mm

PART C: WELD-IN SADDLES

aquatherm-weld-in saddles are available for pipe outer diameter of 40 - 630 mm.

Weld in saddles are used for

- branch connections in existing installations
- the substitution of a reduction-tee
- branch connections in risers
- sensor wells, etc.

The maximum sensor well diameter is specified in the table on page 53.

1. Before starting the welding process, check whether the aquatherm-welding devices and tools comply with the requirements of "Fusion Part A".

2. The first step is to drill through the pipe wall at the intended outlet point by using the aquatherm-drill (Art.-No. 50940-50958).

3. IMPORTANT!

Only the oxygen barrier layer of the aquatherm blue pipe of Art.-No. 2170708-2170138 must be removed with the mentioned aquatherm special peeling drills mentioned in the table beside.

For this the special peeling drill is inserted into the bore hole and swayed 2-3 times with light pressure and low rotating speed between the pipe walls until the oxygen barrier layer is completely peeled off.

Remove burrs, debris and other dirt with a chamfering tool or the aquatherm cleaning wipes. Do not touch the peeled surface any more and protect it from new pollution.

4. The welding device / saddle welding tool must have reached the required operating temperature of 260 °C (check with reference to "Fusion Part B, item 2").

5. The welding surfaces have to be clean and dry.

6. Insert the heating tool on the concave side of the weld in saddle tool into the hole drilled in the pipe wall until the tool is completely in contact with the outer wall of the pipe. Next the weld-in saddle tool is inserted into the heating sleeve until the saddle surface is up against the convex side of the welding tool. The heating time of the elements is generally 30 seconds.

7. After the welding tool has been removed, the weld-in saddle tool is immediately inserted into the heated, drilled hole. Then the weld-in saddle should be pressed on the pipe for about 15 seconds. After being allowed to cool for 10 minutes the connection can be exposed to its full loading. The appropriate branch pipe is fitted into the sleeve on the aquatherm-weld-in saddle using conventional fusion technology.

By fusing the weld-in saddle with the pipe outer surface and the pipe inner wall the connection reaches highest stability.



Drilling through the pipe wall



Removal of the oxygen barrier layer from the aquatherm blue pipe of

aquatherm saddle peeling tools for **aquatherm blue pipe of** pipes Ø 50-125 mm

Art.-No.	Dimension
50921	for weld-in saddles Ø 20 & 25 mm
50922	for weld-in saddles Ø 32 mm
50924	for weld-in saddles Ø 40 mm
50926	for weld-in saddles Ø 50 mm
50928	for weld-in saddles Ø 63 mm

aquatherm saddle peeling tools for **aquatherm blue pipe of** pipes Ø 160-250 mm

Art.-No.	Dimension
50421	for weld-in saddles Ø 20 & 25 mm
50422	for weld-in saddles Ø 32 mm
50424	for weld-in saddles Ø 40 mm
50426	for weld-in saddles Ø 50 mm
50428	for weld-in saddles Ø 63 mm



The welding tool is inserted into the pipe wall ...



... heating-up of the elements



Joining



Ready!

PART C: WELD-IN SADDLES

Art.-No.	Dimension	D	d	l	Drill	Special peeling drill*	Tool
		mm	mm	mm	Art.-No.	Art.-No.	Art.-No.
15156	40/20 mm	40	25	27.0	50940	50920	50614
15158	40/25 mm	40	25	28.0	50940	50920	50614
15160	50/20 mm	50	20	27.0	50940	50921	50616
15162	50/25 mm	50	25	28.0	50940	50921	50616
15164	63/20 mm	63	20	27.0	50940/15941	50921	50619
15166	63/25 mm	63	25	28.0	50940/15941	50921	50619
15168	63/32 mm	63	32	30.0	50942	50922	50620
15170	75/20 mm	75	20	27.0	50940/15941	50921	50623
15172	75/25 mm	75	25	28.0	50940/15941	50921	50623
15174	75/32 mm	75	32	30.0	50942	50922	50624
15175	75/40 mm	75	40	34.0	50944	50924	50625
15176	90/20 mm	90	20	27.0	50940/15941	50921	50627
15178	90/25 mm	90	25	28.0	50940/15941	50921	50627
15180	90/32 mm	90	32	30.0	50942	50922	50628
15181	90/40 mm	90	40	34.0	50944	50924	50629
15182	110/20 mm	110	20	27.0	50940/15941	50921	50631
15184	110/25 mm	110	25	28.0	50940/15941	50921	50631
15186	110/32 mm	110	32	30.0	50942	50922	50632
15188	110/40 mm	110	40	34.0	50944	50924	50634
15189	110/50 mm	110	50	34.0	50946	50926	50635
15190	125/20 mm	125	20	27.0	50940/15941	50921	50636
15192	125/25 mm	125	25	28.0	50940/15941	50921	50636
15194	125/32 mm	125	32	30.0	50942	50922	50638
15196	125/40 mm	125	40	34.0	50944	50924	50640
15197	125/50 mm	125	50	34.0	50946	50926	50642
15198	125/63 mm	125	63	38.0	50948	50928	50644
15206	160/20 mm	160	20	27.5	50940/15941	-	50648
15208	160/25 mm	160	25	28.5	50940/15941	-	50648
15210	160/32 mm	160	32	30.0	50942	50421	50650
15212	160/40 mm	160	40	34.0	50944	50421	50652
15214	160/50 mm	160	50	34.0	50946	50422	50654
15216	160/63 mm	160	63	38.0	50948	50424	50656
15218	160/75 mm	160	75	42.0	50950	50426	50657
15220	160/90 mm	160	90	45.0	50952	50428	50658
15228	200-250/20 mm	200-250	20	27.5	50941	-	50660/50672
15229	200-250/25 mm	200-250	25	28.5	50941	-	50660/50672
15230	200-250/32 mm	200-250	32	30	50942	-	50662/50674
15231	200/40 mm	200	40	34	50944	-	50664
15232	200/50 mm	200	50	34	50946	50424	50666
15233	200/63 mm	200	63	37.5	50948	50426	50668
15234	200/75 mm	200	75	42.0	50950	50428	50667
15235	200/90 mm	200	90	42.0	50952	-	50669
15236	200/110 mm	200	110	49.0	50954**	-	50670
15237	200/125 mm	200	125	55.0	50956**	-	50671
15251	250/40 mm	250	40	34	50944	-	50676
15252	250/50 mm	250	50	34	50946	-	50678
15253	250/63 mm	250	63	37.5	50948	-	50680
15254	250/75 mm	250	75	42.0	50950	-	50682
15255	250/90 mm	250	90	45.0	50952	-	50684
15256	250/110 mm	250	110	49.0	50954**	-	50686
15257	250/125 mm	250	125	55.0	50956**	-	50688
15260	315/63 mm	315	63	37.5	50948	-	50690
15261	315/75 mm	315	75	42.0	50950	-	50692
15262	315/90 mm	315	90	45.0	50952	-	50694
15263	315/110 mm	315	110	49.0	50954**	-	50696
15264	315/125 mm	315	125	55.0	50956**	-	50698
15268	355/90 mm	355	90	45.0	50952	-	50716
15269	355/110 mm	355	110	49.0	50954**	-	50718
15270	355/125 mm	355	125	55.0	50956**	-	50720
15271	355/160 mm	355	160	-	50958	-	50722
15275	400-500/75 mm	400-500	75	-	50950	-	50728
15277	400-450/110 mm	400-500	110	-	50954	-	50736
15278	400/125 mm	400	125	-	50956	-	50742
15288	400-500/90 m	400-500	90	-	50950/52	-	50732
15290	450-500/125 m	400-500	125	-	50956	-	50744
15300	400-630/63 mm	400	63	-	50948	-	50726
15303	500-560/110 mm	500-560	110	-	50954	-	50738
15315	560-630/75 mm	560-630	75	-	50950	-	50730
15316	560-630/90 mm	560-630	90	-	50952	-	50734
15318	560-630/125 mm	560-630	125	-	50956	-	50746
15331	630/110 mm	630	110	-	50954	-	50740

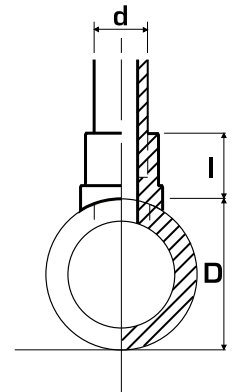

* only for aquatherm blue pipe OT faser composite pipes, Art.-No. 2170708 - 2170138
 ** tool holder MK4

PART C: WELD-IN SADDLES

Art.-No.	Dimension	D	d	l	Sensor-wels	Drill	Special peeling drill*	Tool
		mm	mm	mm	Art.-No.	Art.-No.	Art.-No.	Art.-No.
28214	40/25 x 1/2" IG.	40	1/2"	39,0	14	50940	50920	50614
28216	50/25 x 1/2" IG.	50	1/2"	39,0	14	50940	50921	50616
28218	63/25 x 1/2" IG.	63	1/2"	39,0	14	50940/15941	50921	50619
28220	75/25 x 1/2" IG.	75	1/2"	39,0	14	50940/15941	50921	50623
28222	90/25 x 1/2" IG.	90	1/2"	39,0	14	50940/15941	50921	50627
28224	110/25 x 1/2" IG.	110	1/2"	39,0	14	50940/15941	50921	50631
28226	125/25 x 1/2" IG.	125	1/2"	39,0	14	50940/15941	50921	50636
28230	160/25 x 1/2" IG.	160	1/2"	39,0	14	50940/15941	50921	50648
28232	200-250/25 mm x 1/2" IG.	200-250	1/2"	39,0	14	50941	50921	50660 / 50672
28234	40/25 x 3/4" IG.	40	3/4"	39,0	16	50940	50920	50614
28236	50/25 x 3/4" IG.	50	3/4"	39,0	16	50940	50921	50616
28238	63/25 x 3/4" IG.	63	3/4"	39,0	16	50940/15941	50921	50619
28240	75/25 x 3/4" IG.	75	3/4"	39,0	16	50940/15941	50921	50623
28242	90/25 x 3/4" IG.	90	3/4"	39,0	16	50940/15941	50921	50627
28244	110/25 x 3/4" IG.	110	3/4"	39,0	16	50940/15941	50921	50631
28246	125/25 x 3/4" IG.	125	3/4"	39,0	16	50940/15941	50921	50636
28250	160/25 x 3/4" IG.	160	3/4"	39,0	16	50940/15941	50921	50648
28254	200-250/25 mm x 3/4" IG.	200-250	3/4"	39,0	16	50941	50921	50660 / 50672
28260	75/32 x 1" IG.	75	1"	43,0	20	50942	50922	50624
28262	90/32 x 1" IG.	90	1"	43,0	20	50942	50922	50628
28264	110/32 x 1" IG.	110	1"	43,0	20	50942	50922	50632
28266	125/32 x 1" IG.	125	1"	43,0	20	50942	50922	50638
28270	160/32 x 1" IG.	160	1"	43,0	20	50942	50922	50650
28274	200-250/32 mm x 1" IG.	200-250	1"	43,0	20	50942	50922	50662 / 50674

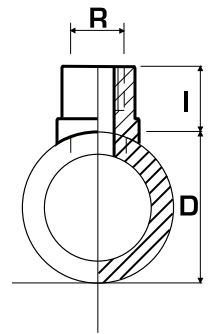

Art.-No.	Dimension	D	d	l	Drill	Special peeling drill*	Tool
		mm	mm	mm	Art.-No.	Art.-No.	Art.-No.
28314	40/25 x 1/2" AG.	40	1/2"	55,0	15940	50920	50614
28316	50/25 x 1/2" AG.	50	1/2"	55,0	15940	50921	50616
28318	63/25 x 1/2" AG.	63	1/2"	55,0	15940/15941	50921	50619
28320	75/25 x 1/2" AG.	75	1/2"	55,0	15940/15941	50921	50623
28322	90/25 x 1/2" AG.	90	1/2"	55,0	15940/15941	50921	50627
28324	110/25 x 1/2" AG.	110	1/2"	55,0	15940/15941	50921	50631
28326	125/25 x 1/2" AG.	125	1/2"	55,0	15940/15941	50921	50636
28330	160/25 x 1/2" AG.	160	1/2"	55,0	15940/15941	50921	50648
28334	40/25 x 3/4" AG.	40	3/4"	56,0	15940	50921	50614
28336	50/25 x 3/4" AG.	50	3/4"	56,0	15940	50921	50616
28338	63/25 x 3/4" AG.	63	3/4"	56,0	15940/15941	50921	50619
28340	75/25 x 3/4" AG.	75	3/4"	56,0	15940/15941	50921	50623
28342	90/25 x 3/4" AG.	90	3/4"	56,0	15940/15941	50921	50627
28344	110/25 x 3/4" AG.	110	3/4"	56,0	15940/15941	50921	50631
28346	125/25 x 3/4" AG.	125	3/4"	56,0	15940/15941	50921	50636
28350	160/25 x 3/4" AG.	160	3/4"	56,0	15940/15941	50921	50648

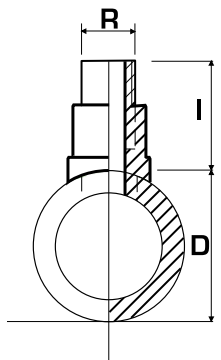

* only for aquatherm blue pipe OT faser composite pipes, Art.-No. 2170708-2170130

PART D: PULLING JIG (HITCH)

Notice

The following description of the electric pulling jig applies to the type of the year 2013.

Operation and fusion

With the help of the electric pulling jig, all aquatherm PP-R pipes and fittings in dimensions from 63 to 125 mm are in a very simple manner without any effort welded together.

Also the pulling jig simplifies the welding of pipes and fittings under ceilings, in narrow shafts and other hard-to-reach places.



1. Preparation for the fusion

Mark the welding depth with the included green marking template on the pipe end. (Fig. 1). In addition, the clamping depth is measured 2 cm from the welding depth marking and marked again. (Fig. 2 +3)

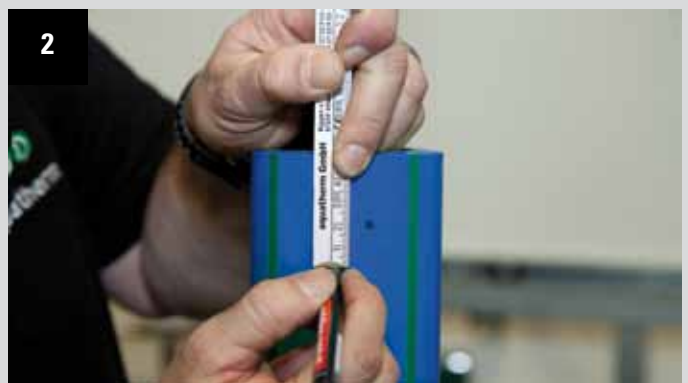

The pulling jig is now placed on the fitting or pipe to be welded with the clamping jaws. (Fig. 4)



The two arrows of the jaws and the machine must be flush with each other. The jaws are to be fixed with the help of the clamping device (Fig. 5).

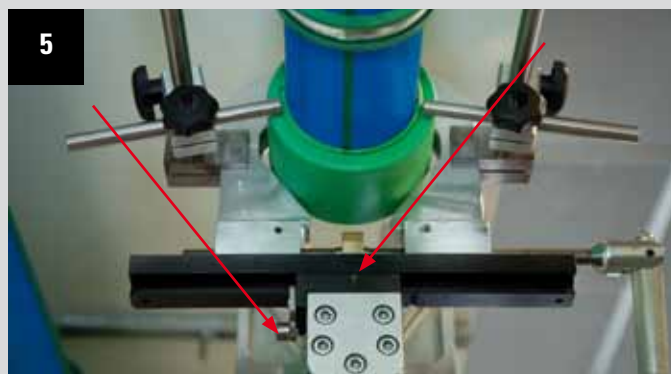

Align the pipe so that the rear marking is flush with the inner edge of the clamping jaw. The front marking identifies the welding depth (Fig. 6).

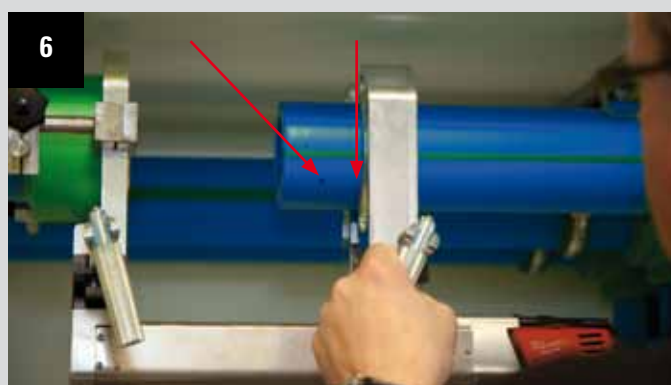

Lock pipe and fitting by using the front adjusting screws. (Fig. 7)



Never clamp so tight that deformations appear. Additionally, with the fitting support, all fittings are supported. The support is mounted on the clamping jaw for fittings. (Fig.8)



PART D: PULLING JIG (HITCH)

2. Fusion

Hold the welding device between pipe and fitting and ride machine carriage in batches together (pay attention to the welding depth).

Basically the jaws must be released after the insertion of pipe and fitting in the welding tool by a short return of the machine (3-7 mm)! The jaws must always be parallel to each other. (Fig. 9 +10)

After finishing of the warm-up drive the machine carriage apart and remove the welding device. (Fig. 11)

Ride the jaws together again and release the clamping jaws again by a short return of the machine (3-7 mm). (Fig. 12)

CAUTION:

Jaws may be released only after the expiry of the cooling time!

Pipe and fitting are now joined by fusion to a material unit. (Fig. 13)

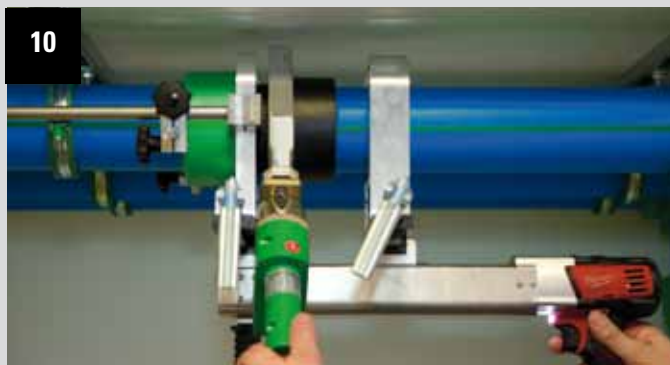

Pipe external mm	Welding depth mm	Heating time		Welding time	Cooling time
		sec. DVS	sec. AQE*	sec.	min.
63	27,5	24	36	8	6
75	30,0	30	45	8	8
90	33,0	40	60	8	8
110	37,0	50	75	10	8
125	40,0	60	90	10	8

*heating times recommended by aquatherm at ambient temperatures below +5 °C.

The General Guidelines for Heated Socket Welding acc. to DVS 2207, Part 11 are applied hereupon.

PART E: AQUATHERM-WELDING MACHINE

for stationary processing 50 – 125 mm

precise pre-assembly and facilitation by hand creek

clamping jaws 50 – 125 mm, tools 50 – 125 mm,

Scope of supply:

wooden transport box, slide with sub construction, clamping jaws 50 - 125 mm, welding tools 50 - 125 mm, stay with rolls

For welding of aquatherm blue pipe a welding temperature of 260 °C at the welding tools is necessary (see page 47).

Instructions for use can be taken from the attached operation manual.

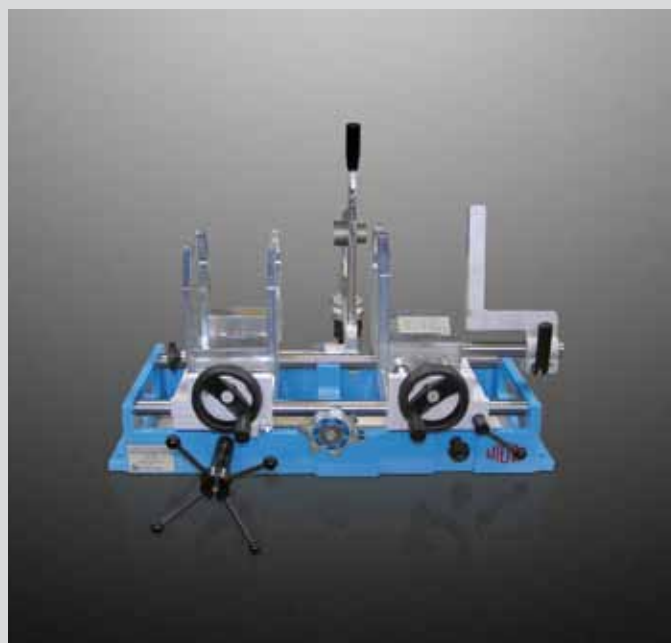

The fusion is subject to the following data

Pipe external-Ø	Welding depth	Heating time		Welding time	Cooling time
		sec. DVS	sec. AQE*	sec.	min.
50	23,5	18	27	6	4
63	27,5	24	36	8	6
75	30,0	30	45	8	8
90	33,0	40	60	8	8
110	37,0	50	75	10	8
125	40,0	60	90	10	8

The general guidelines for heated tool socket welding acc. to DVS 2207 part 11 are applied hereupon.

*heating times recommended by aquatherm at ambient temperatures below + 5 °C

Dimension 160-630 mm:

The dimension 160-630 mm are joined by butt-welding.

Detailed information on page 64 + 65.

PART E: WELDING MACHINE PRISMA-LIGHT

welding machine prisma-light with heating plate without tools

clamping fixture for fixing the prisma-light e. g. at the work bench

1. Check machine: temperature lamp blinks after reaching the welding temperature (260° C), adjust clamping jaws 63 – 125 mm coarsely. Mark welding depth with the template at the pipe.
2. Fix the fitting against the clamping jaws.
3. Place the pipe loose in the opposite clamping jaws.
4. Position the welding device centrally to the pipe-fitting axis and remove it.
5. Lock the front calibration knob and drive up the slide as far as it will go.
6. In this position push the pipe against the fitting and fix it with the clamping jaws.
7. Regulate the welding time according to the table on page 57, place the welding device and push the fitting and pipe slowly as far as it will go up to the marking.
8. The heating time starts when pipe and fitting are completely pushed on the tool. When heating time is complete slide return the slide, remove the heating device quickly and join the pipe and fitting.
9. Consider cooling times from the table on page 57.

More detailed information can be taken from the enclosed operating manuals.



PART F: ELECTROFUSION DEVICE

Fusion

The aquatherm-electrofusion device was specially developed for electro-fusion sockets from Ø 20 - 250 mm.

The fusion of 160-250 mm aquatherm blue -faser composite pipes UV-resistant with the electrofusion socket Art.-No. 17230 is not possible.

Technical information:

supply voltage: 230 V (nominal voltage)
 nominal capacity: 2.800 VA, 80 % ED
 rated frequency: 50 Hz - 60 Hz
 protection class: IP 54

1. General and inspection

Cleanliness is - besides correct workmanship - the most important pre-condition for a correct fusion. For keeping the sockets clean do not un-wrap them before processing.

The pipe surface must also be clean and undamaged. Deformed pipe ends must be cut off.

All parts of the system to be fused as well the temperature sensors shall have the same temperature (e.g. sun radiation or unadapted storing may cause differences in temperature!) within the acceptable range of temperature (e.g. +5 °C to 40 °C according to DVS 2207).

2. Preparation

Follow carefully the order of working steps!

Preparation is one of the most important steps of the electrofusion process!

- a. Cut the ends of the pipes rectangularly and deburr them thoroughly
- b. Clean and dry the ends of the pipes at the necessary length
- c. Mark the depth of aquatherm-electro-fusion-socket on the end of the pipe



aquatherm electrofusion device Ø 20-250 mm



aquatherm electrofusion socket



aquatherm peeling tool (Art.-No. 50558-70, up to 75 mm) (from 90-160 mm: Art.-No. 50572-50592 (without picture))

Welding depth up to 250 mm

Ø	20	25	32	40	50	63	75	90	110	125	160	200	250
ET	35,0	39,0	40,0	46,0	51,0	59,0	65,0	72,5	80,0	86,0	93,0	105,0	125,0

TEIL F: ELECTROFUSION DEVICE

Fusion

- d. Peel the surface of both pipes up to the marks thoroughly with a peeling tool (use the aquatherm-peeling tool with the respective pipe diameter)

IMPORTANT!

Before the fusion peel off the oxygen barrier layer of the aquatherm blue pipe OT and the UV-layer of the fasar-composite-pipe-UV completely to the stop by using the double peeling tools (Art.-No. 50507, 50511, 50516, 50519, 50525) considering the pipe diameter.

By turning the adjusting screw clockwise to the stop, the peeling tools can be adjusted into small depths (sockets), by turning them counter clockwise up to the stop they can be adjusted into big peeling depth (electrofusion sockets).

e. Clean again thoroughly

Without complete peeling of the fusion surface a homogeneous and tight welding connection is not assured. Damages of the surface like axial grooves and scratches are not accepted in the fusion zone. Never touch peeled surfaces and protect them against dirt and grease. Start the fusion process within 30 mins after peeling.

3. Assembling the electrofusion sockets

Avoid soiling and fix all parts securely!

1. Open the protective wrapping of the aquatherm-electrofusion sockets (cut with knife along the edge of the bore), leaving the rest of the foil intact. Clean the inside of the fitting carefully with aquatherm-cleaning wipes. Assemble the fitting within 30 mins after opening of the protective foil.
2. Push the aquatherm-electrofusion sockets on the clean and dry end of the pipe (up to the marked depth). Use pressing clamps if necessary.

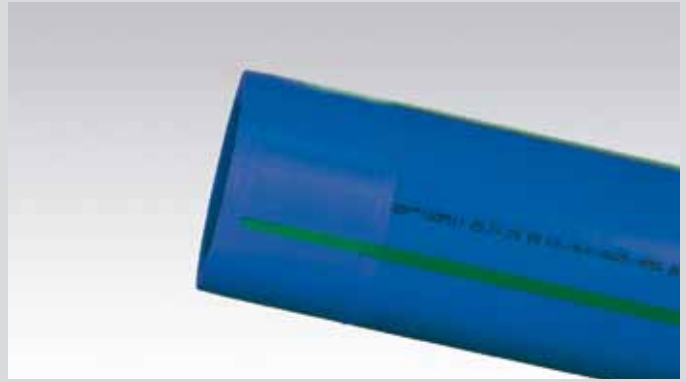

Cut, peel and clean the pipes to be welded carefully



Clean the inner surface of the electrofusion socket



Push the electrofusion socket onto the pipe end



PART F: ELECTROFUSION DEVICE

Remove the protective foil completely and push the other prepared pipe end into the aquatherm-electro-fusion sockets tighten in the fixation.

Leave the pipes, free from bending stress or own weight, within the aquatherm - electrofusion socket. the socket is movable at both pipe ends after assembling. The air gap has to be even around the circumference. A non stress-free, resp. displaced connection can effect an unacceptable melt-flow and a defective connection while joining. The pipe ends and electro-fusion sockets have to be dry when installed.

4. Fusion process

1. Position the fitting with even air gap around the circumference.
2. Regulate fusion equipment for the right fusion parameter.
3. Compare the indications of the fusion equipment with the parameters of the label.
4. Start and watch the fusion process.

Do not move or stress pipe and fitting during the whole fusion process and cooling time.

5. Cooling time and pressure test

A fused pipe-joint shall not be moved (no release of the fixation) or stressed before complete cooling.

The minimum required cooling time is marked on each aquatherm electro-fusion socket. Ambient temperatures of more than 25 °C or strong sun-radiation need longer cooling times.

Working pressure

The operation pressure can be taken from the imprint on the electric welding socket. The relation between working temperature, pressure load and service life is given in the tables "Permissible working pressure."

For further information concerning electrofusion socket and details about the aquatherm-electrofusion device read the enclosed operating instructions.



Push the second pipe - also peeled and cleaned - into the socket

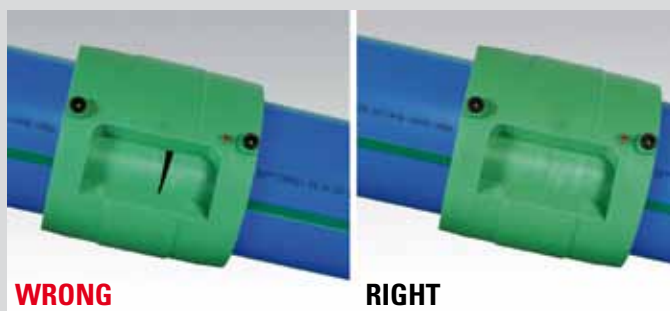

For a stable welding result it is important that both pipe ends inside the electrofusion socket are with parallel faces! Follow the minimum welding depth - absolutely!



Adjust the socket diameter on the welding device. Start and control welding process. Keep the cooling time. Finished!

Kind of stress	Compressive stress	Minimum waiting period
Tension, bend, torsion of unpressurized pipes		20 minutes
Test- or working pressure of pipes pressurized	up to 0.1 bar (1.5 psi)	20 minutes
	0.1 up to 1 bar (1.5-14.5 psi)	60 minutes
	over 1 bar (14.5 psi)	120 minutes
Repeating of the welding process		60 minutes

FLANGE CONNECTIONS

THE FOLLOWING MUST BE OBSERVED IN THE USE OF FLANGE CONNECTIONS:

Flange adapter respectively the sealing surfaces must always be aligned parallel to each other. A subsequent tightening of the flange connection after the welding process must be avoided. It is important to ensure that the flange faces are clean and undamaged.

The screw length should be selected so that the screw thread is as flush as possible, maximum two threads from the nut. To distribute the force of the screw head and the nut over a larger area, washers are used. Screws, nuts and washers must be clean and undamaged.

In order to achieve proper force distribution (surface pressure) acting on the seal, note the following:

- Screw joints must be tightened diagonally and evenly
- Torque information on the individual flanges must be observed (see table)

For flange connections, exposed to a mutual load, take care that they are checked as part of the maintenance and retightened, if necessary.

TORQUE FLANGE according to manufacturer's instructions

Art.-No.	Dimension	DN specification	Nm
15712	32mm	25	15
15714	40mm	32	20
15716	50mm	40	30
15718	63mm	50	35
15720	75mm	65	40
15722	90mm	80	40
15724	110mm	ohne	50
15726	125mm	100	50
15730	160mm	125	60
15734	200mm	150	75
15738	250mm	200	95
15742	315mm	250	100
15744	355mm	300	100
15746	400mm	350	244-366
15748	450mm	400	271-407
15750	500mm	450	271-407
15752	560mm	500	353-529
15754	630mm	500	393-590

TIGHTENING SEQUENCE

Number of screws	Criss-Cross Pattern Tightening Sequence
4	1 - 2 - 3 - 4
8	1 - 5 - 3 - 7 >> 2 - 6 - 4 - 8
12	1 - 7 - 4 - 10 >> 2 - 8 - 5 - 11 >> 3 - 9 - 6 - 12
16	1 - 9 - 5 - 13 >> 3 - 11 - 7 - 15 >> 2 - 10 - 6 - 14 >> 4 - 12 - 8 - 16
20	1 - 11 - 6 - 16 >> 3 - 13 - 8 - 18 >> 5 - 10 - 15 - 20 >> 2 - 12 - 7 - 17 >> 4 - 14 - 9 - 19

Following the table, tighten the given screw number to the desired torque value for the given round of tightening.

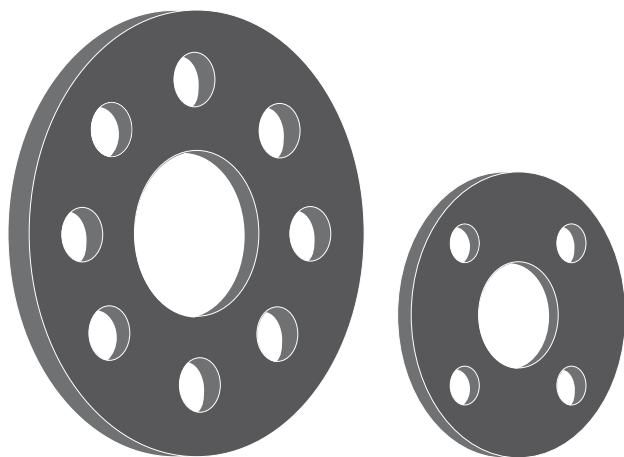
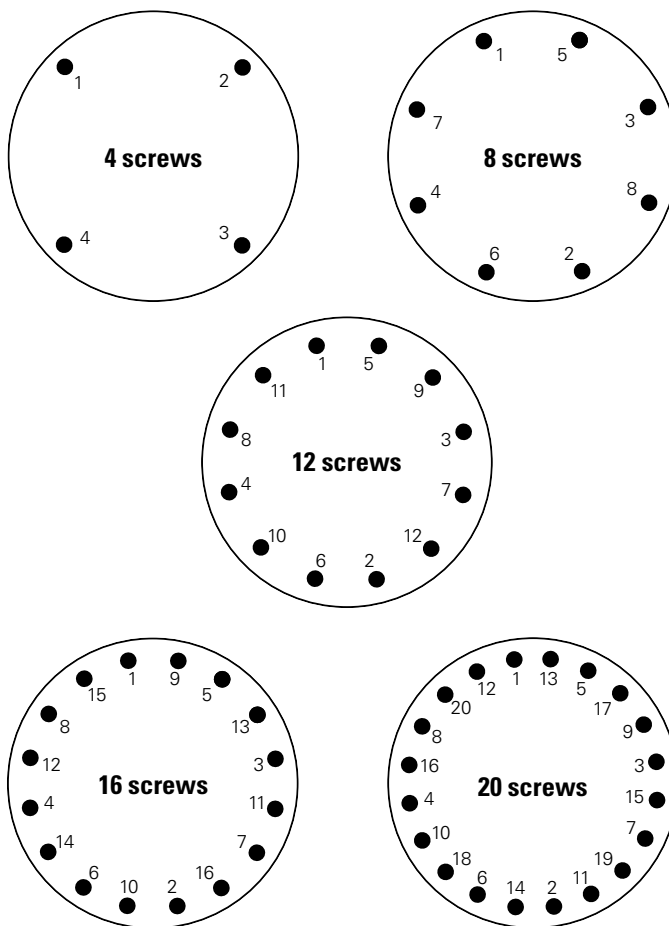

POSSIBILITIES OF REPAIR

Pipe repairs with the aquatherm green pipe-electrofusion socket

Cut squarely 3 to 4 lengths of a fitting out of the defect pipe, symmetrically to the defect. Fit the new pipe into this gap. Prepare the pipe ends of the existing pipe as in the case of a new welding.

Peel the new piece of pipe on both sides with the peeling tool on a length of more than the length of one fitting.

Unwrap two fittings and carefully move the fittings over both ends of the new pipe.

Then place the repair-pipe into the gap and move the fittings until they are aligned with the markings on the existing pipes.

Take care, that the fittings are exactly aligned and completely free of stress before welding.

Additional possibilities of repair

Damaged pipes may be repaired - as already mentioned - by means of

fusion (see Part B)
electrofusion socket (see Part F).

In addition to this the aquatherm PP-R- systems offers the possibility of the

pipe repair stick.

The necessary welding tool (Art.-No. 50307/11) and repair stick (Art.-No. 60600) are described on page 158.

The installation information is enclosed with the welding tool, but may also be ordered separately (Order-No. D 11450) from aquatherm.

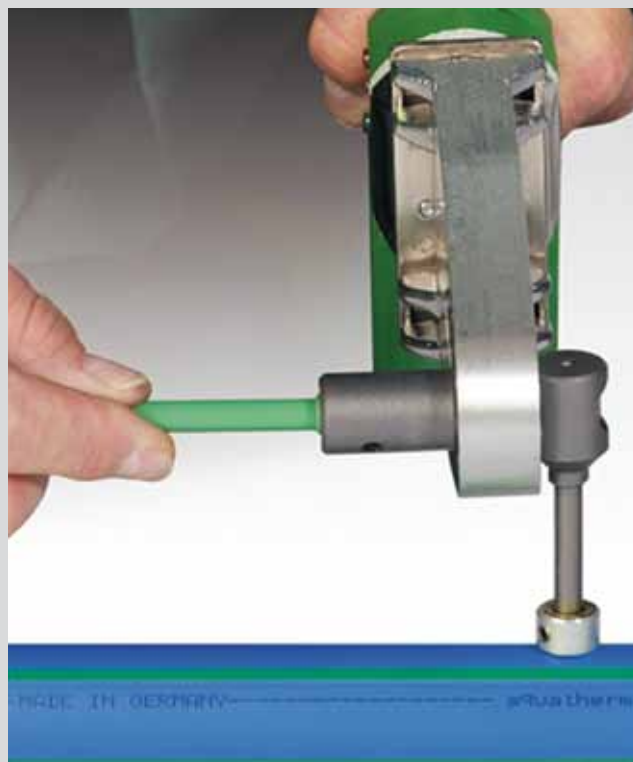

Heat-up

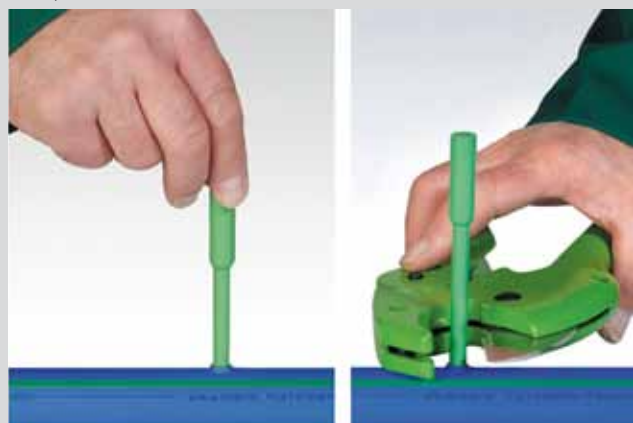

Repair stick

Cutting

**PART H: BUTT-WELDING OF PIPE DIMENSION
160 - 630 MM**

The following aquatherm - pipes series are available:

aquatherm blue pipe SDR 11 MF faser-composite pipe

aquatherm blue pipe SDR 11 MF OT faser-composite pipe

aquatherm blue pipe SDR 17,6 MF faser-composite pipe

Pipes and fittings are fused, as explained below, by butt welding:

1. Protect your place of work from weather influences
2. Check, if welding machine works properly and heat it up
3. Cut pipes into required length
4. Plastic pipes are aligned and fixed by means of the clamping elements
5. Use the milling machine for planing the pipe end to be plane-parallel
6. Remove the debris and clean the pipe ends with methylated spirit
7. Check if pipes match (tolerance: max. 0.1 x wall thickness)
8. Check width of gap between the two pipes to be welded (tolerance: max. 0.5 mm)
9. Check the temperature of the heating element (210° C +/- 10° C)
10. Clean the heating element

IMPORTANT:

Before welding, aquatherm blue pipe OT pipes have to be burred at the front. To ensure an optimal weld joint, the heating plates' surfaces have to be cleaned before each welding process and be free of visible and invisible residues.



Before welding, pipes are cut into the required lengths

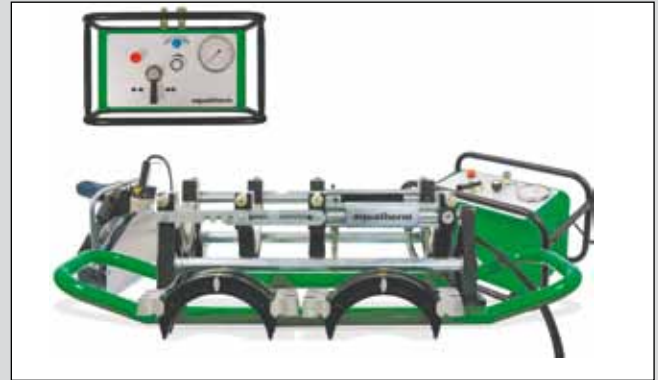

Check performance of the welding machine and heat it up

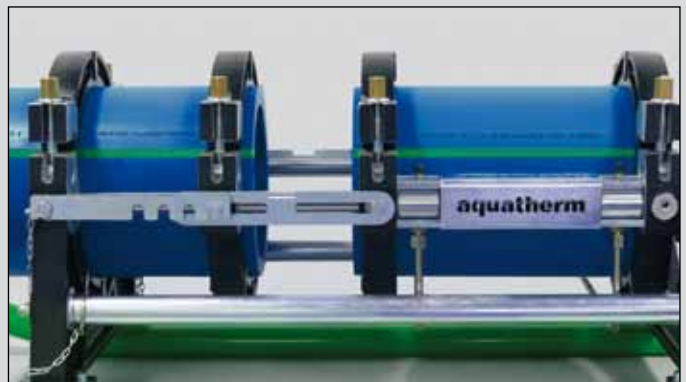

The parts to be welded are fixed and aligned respectively, the milling machine is used

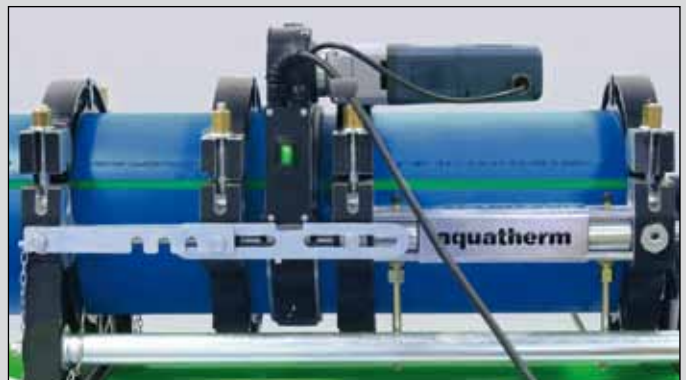

**PART H: BUTT-WELDING OF PIPE DIMENSION
160 - 630 MM**

11. After the heating element has been positioned, the pipes are pushed onto the heating plate with a defined adjusting pressure.
12. After reaching the specified bead height (see tablet) the pressure is reduced. This process marks the beginning of the heating time. This time is for heating up the pipe ends up to the right welding temperature.

Specified bead height in mm:

	SDR 11	SDR 17,6
160 mm	1,0	1,0
200 mm	1,0	1,0
250 mm	1,5	1,0
315 mm	2,0	1,0
355 mm	2,0	1,5
400 mm	2,0	1,5
450 mm	2,5	1,5
500 mm		2,0
560 mm		2,0
630 mm		2,0

13. When heating time has expired, divide the machine slide, remove heating element quickly and join the pipes (by putting both parts of the slide together).
14. The pipes are fused with the required welding pressure and cooled down under pressure.
15. The welded connection can be unclamped - the welding process is finished.

Additionally please follow the instructions given in the operating manual of the welding machine and observe guideline DVS 2207, part 11.

Important Note

1. The welding machines have to be suitable for the welding of pipes with a diameter/wall thickness ratio of up to SDR 7.4

aquatherm recommends the following manufacturers of welding machines for butt welding:

- Company Ritmo
- Company Rothenberger
- Company Widos

2. For hydraulically operated welding machines, the real manometer pressure has to be calculated in consideration of the hydraulic piston area.

This value can be taken from the respective operating manuals.

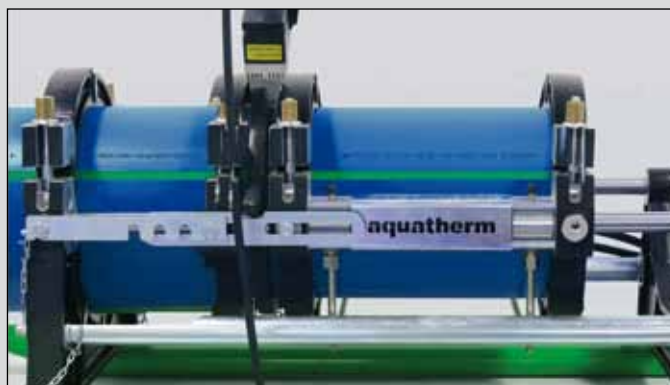

Positioning of heating element

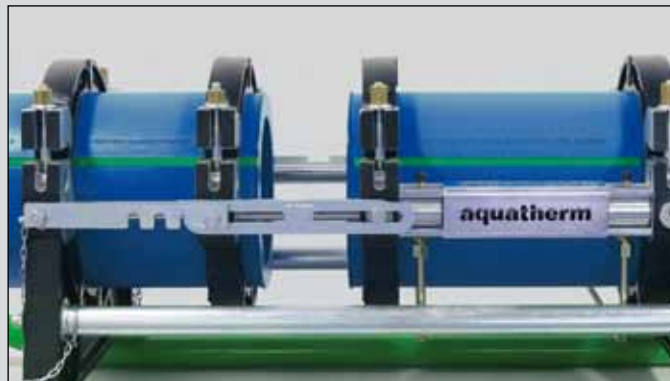

Divide the machine slide, remove heating element

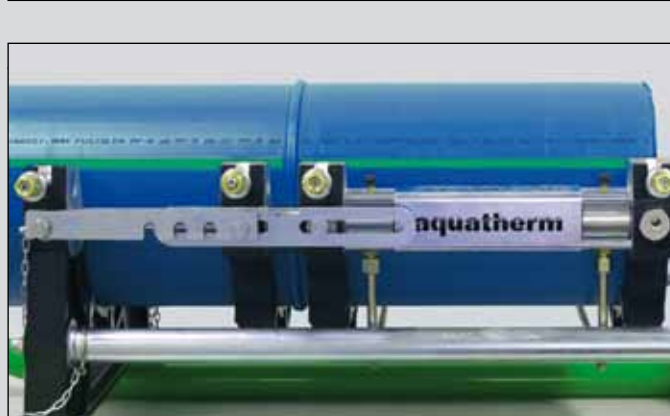
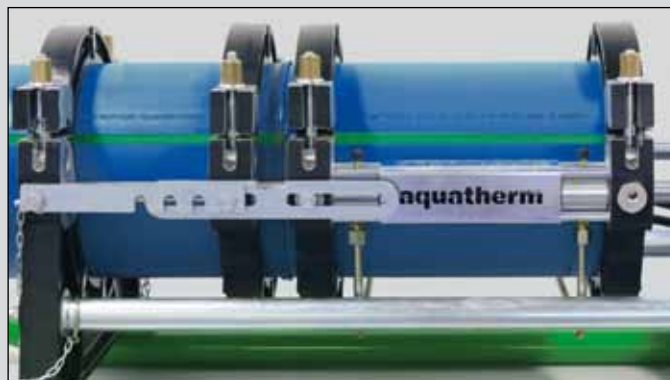

Unclamp and work on...

Visual inspection of fusion seam - Misalignment and gap width for butt welding

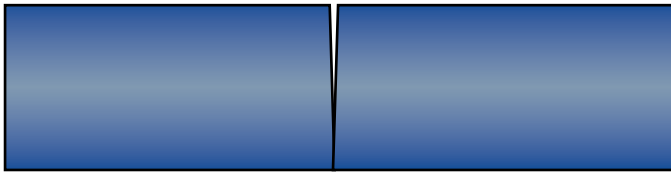

Gap width up to 355 mm outer diameter = 0.5 mm
 Gap width from 400 mm to 630 mm outer diameter = 1 mm

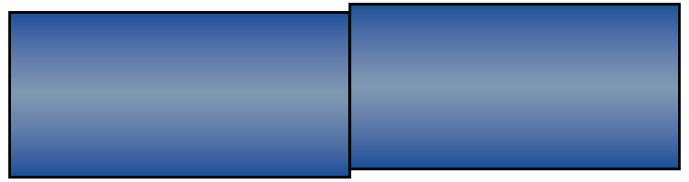

The misalignment cannot be more than 10 % of the wall thickness or max. 2 mm

Welding defects during butt-welding

Normally a bead around the entire circumference is formed at the edge of the socket during the welding process. This bead indicates the proper welding. It is important to assure that the following welding defects are avoided:

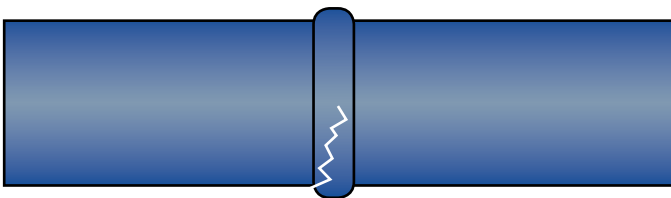

Cracks

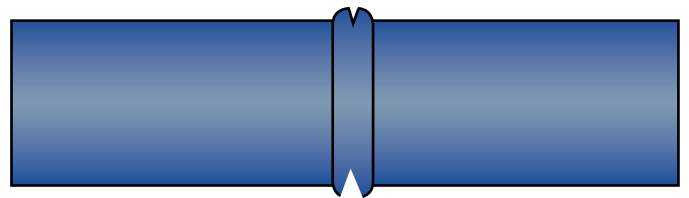

Grooves in the bead

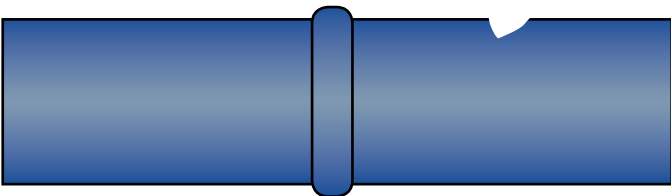

Grooves and scratches

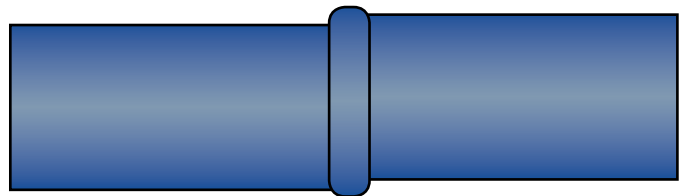

Misalignment of the joining area

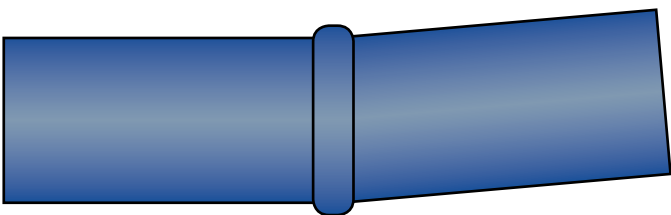

Tilting of the joining area

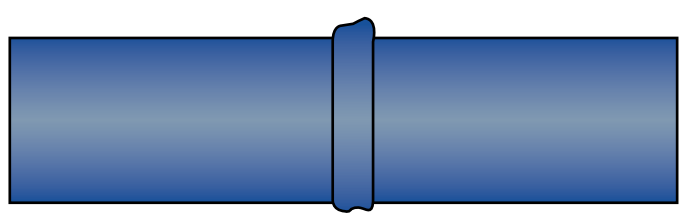

Uneven welding bead

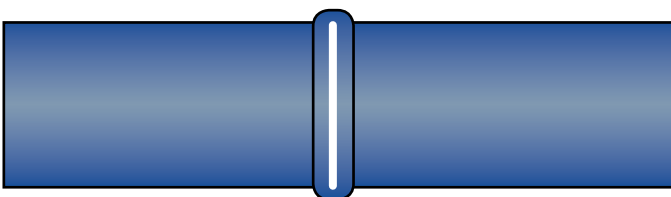

Lack of fusion at the joining area

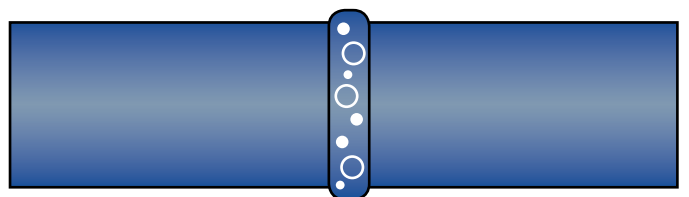

Pores, voids and inclusion of impurities

Correct butt welded seam

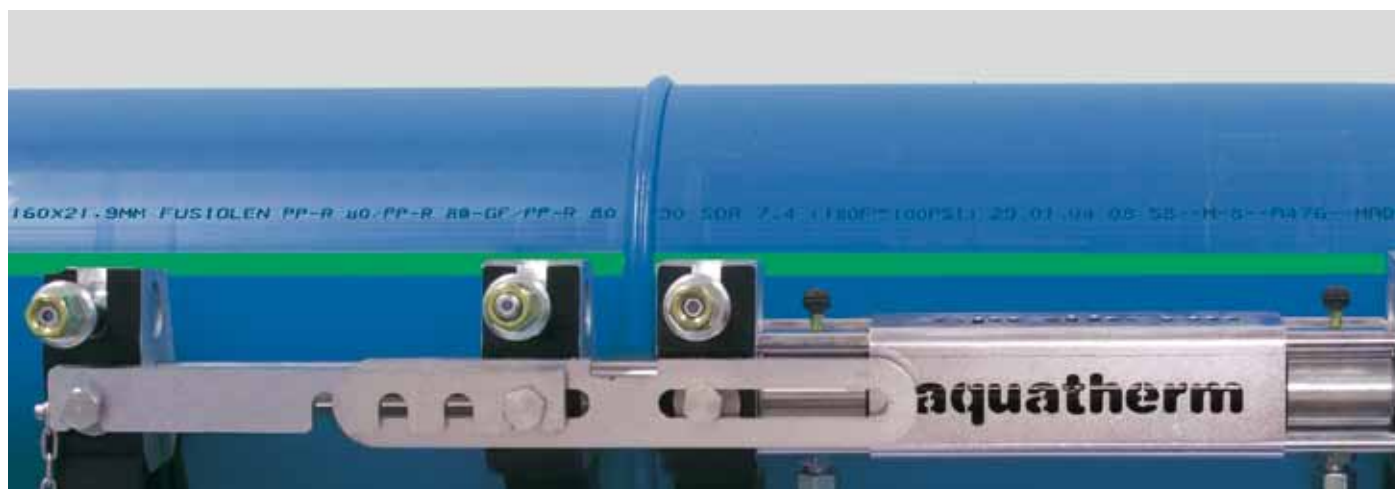

**The visual inspection may be only a first indication of the welding seam quality.
But it is not a replacement for the leak test, which has to be carried out after the completion of the installation.**

Requirements for welding



The immediate welding area is to be protected against bad climatic conditions (e.g. wind, moisture and low temperatures).



If the pipes are heated unevenly as a result of sun exposure, temperature compensation by timely covering of the welding area is to be created. Cooling down by draft during the welding process should be avoided.



For perfect welding joints, both the welding areas and tools must be clean and free of grease.

AQUATHERM WELDING PARAMETERS
WELDING TEMPERATURE: 210° C +/- 10° C

The calculated drag pressure is added to the adjustment and welding pressure (see description)

ATTENTION: When using other welding machines, the pressures P1, P2 and P3 must be adjusted.

Excerpt from the DVS 2207 part 11

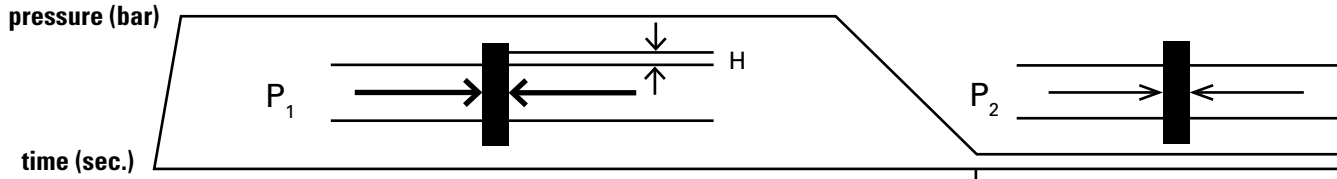

Dimension (mm)	Pipe series SDR	P1 Adjustment pressure (bar)					Height of bead (mm)	P2 Heating pressure (bar)		
		Rothenberger Art.-No. 50163, 50167 + 50178	Ritmo Art.-No. 50165	Ritmo Art.-No. 50166	Ritmo Art.-No. 50177	Ritmo Art.-No. 50169		Rothenberger Art.-No. 50163, 50167 + 50178	Ritmo Art.-No. 50165	Ritmo Art.-No. 50166
160x9,1	17,6	7	7	6	3		1	1	1	
160x14,6	11	11	11	10	5		1	1	1	
160x17,9	9	13	13	12	6		1	1	1	
160x21,9	7,4	15	16	14	7		1,5	2	2	
200x11,4	17,6	11	11	10	5		1	1	1	
200x18,2	11	17	18	16	7		1	2	2	
200x22,4	9	20	21	19	9		1,5	2	2	
200x27,4	7,4	24	25	22	11		2	2	2	
250x14,2	17,6	17	18	16	7		1	2	2	
250x22,7	11	26	28	24	11		1,5	3	3	
250x27,9	9	31	33	29	14		2	3	3	
250x34,2	7,4	37	39	35	16		2	4	4	
315x17,9	17,6	27		25	12	8	1	3	3	
315x28,6	11	41		38	18	13	2	4	4	
315x35,2	9	49		46	22	15	2	5	5	
315x42,6	7,4	59		56	26	18	2,5	6	6	
355x20,1	17,6	34			15	10	1,5	3		
355x32,2	11	52			23	16	2	5		
355x39,5	9	63			28	19	2,5	6		
355x49,0	7,4	77			33	23	2,5	7		
400x22,7	17,6					13	1,5			
400x36,3	11					20	2			
400x44,5	9					24	2,5			
450x25,5	17,6					17	1,5			
450x40,9	11					26	2,5			
500x28,4	17,6					21	2			
500x45,5	11					32	2,5			
560x31,7	17,6					26	2			
630x35,7	17,6					33	2			

Note: A reduction of the cooling time up to 50%, i.e. release of the jointing pressure and removal of the welded part from the welding machine is allowed under the following conditions:

- the joint connection is manufactured under factory conditions and
- the removal from the welding machine and the temporary storage cause only a slight load to the joint connection and
- the joining parts have a wall thickness ≥ 15 mm

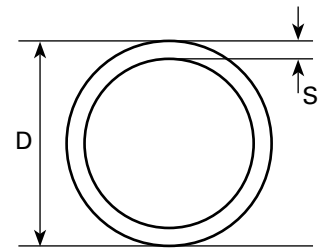

Further processing with full mechanical load on the jointing connection may be effected only after complete cooling down according to the table.

		t_2			t_3					t_4	
					P ₃						
					Adjustment pressure (bar)						
Ritmo Art.-No. 50177	Ritmo Art.-No. 50169	Heating time DVS 2207 (sec.)	Max. changeover time (sec.)	Max. pressurization time (sec.)	Rothenberger Art.-No. 50163, 50167 + 50178	Ritmo Art.-No. 50165	Ritmo Art.-No. 50166	Ritmo Art.-No. 50177	Ritmo Art.-No. 50169	Cooling time (min.)	
		t ₁	t ₂	t ₃						t ₄	
0		204	6	9	7	7	6	3		15	
0		277	8	13	11	11	10	5		24	
1		315	9	16	13	13	12	6		28	
1		359	10	19	15	16	14	7		34	
0		237	7	11	11	11	10	5		19	
1		320	9	16	17	18	16	7		29	
1		364	10	19	20	21	19	9		35	
1		411	11	23	24	25	22	11		42	
1		272	8	13	17	18	16	7		23	
1		367	10	20	26	28	24	11		35	
1		415	12	24	31	33	29	14		43	
2		463	13	29	37	39	35	16		51	
1	1	317	9	16	27		25	12	8	28	
2	1	412	12	24	41		38	18	13	44	
2	2	471	14	30	49		46	22	15	53	
3	2	520	15	37	59		56	26	18	62	
1	1	341	9	18	34			15	10	32	
2	2	448	13	28	52			23	16	48	
3	2	501	15	34	63			28	19	58	
3	2	551	17	42	77			33	23	68	
	1	367	10	20					13	35	
	2	480	14	31					20	54	
	2	528	16	39					24	63	
	2	395	11	22					17	39	
	3	508	15	35					26	59	
	2	419	12	24					21	43	
	3	534	16	39					32	65	
	3	444	12	27					26	48	
	3	475	14	31					33	53	

FASTENING TECHNIQUE / FIXED POINTS / SLIDING POINTS

Fastening technique

Pipe clamps for aquatherm PP-R - pipes must be dimensioned for the external diameter of the plastic pipe.

Take care, that the fastening material does not mechanically damage the surface of the pipe (aquatherm-pipe clamps Art.-No.: 60516 - 60660).

All pipes should be fastened with only aquatherm’s green rubber compound fasteners, with expansion spacers, or other as deemed equal or approved by aquatherm and /or the project’s Hydraulic Consultant.

Basically it must be distinguished on pipe assembly, whether the fastening material is used as

a fixed point or
a sliding point.

Fixed points

On locating fixed points the pipelines are divided into individual sections. This avoids uncontrolled movements of the pipe.

In principle fixed points have to be measured and installed in a way, that the forces of expansion of aquatherm PP-R- pipes as well as probable additional loads are accommodated.

On using threaded rods or threaded screws the drop from the ceiling should be as short as possible. Swinging clamps should not be used as fixed points.

Basically vertical distributions can be installed. Risers do not require expansion loops, provided that fixed points are located immediately before or after a branch.

To compensate the forces arising from the linear expansion of the pipe there must be sufficient and stable clamps and mountings.

aquatherm-pipe clamps meet all mentioned requirements and - when considering the following installation instructions - are perfect for fixed point installations.

Sliding points

Sliding clamps have to allow axial pipe movements without damaging the pipe.

On locating a sliding clamp it has to be ensured that movements of the pipelines are not hindered by fittings or armatures installed next to the clamps.

aquatherm-pipe clamps have an extra even and sliding surface of the sound insulation insert.

INSTALLATION ADVICE / LINEAR EXPANSION / CONCEALED INSTALLATION

Installation advices

aquatherm-pipe clamps are perfectly suited for fixed point and sliding point installations.

The application of distance rings depends on the type of pipe.

Fastening	MF Pipes (faser composite pipe) & S Pipes (single layer)
Sliding Point	1 distance ring
Fixed point	no distance ring

Linear expansion

The linear expansion of pipes depends on the difference of operating temperature to installation temperature:

$$\Delta T = T_{\text{operating temperature}} - T_{\text{installation temperature}}$$

Therefore cold water pipes have practically no linear expansion.

Because of the heat dependent expansion of the material, the linear expansion must especially be considered in case of hot and heating installations. This requires a distinction of the types of installation, e.g.

- **concealed installation**
- **installation in ducts**
- **open installation.**

Concealed installation

Concealed installations generally do not require a consideration of the expansion of aquatherm PP-R - pipes.

The insulation acc. to DIN 1988 or the EnEV (Energie-einsparverordnung) provides enough expansion space for the pipe. In the case where the expansion is greater than the room to move in the insulation, the material absorbs any stress arising from a residual expansion.

The same applies to pipes, which do not have to be insulated acc. to current regulations.

A temperature induced linear expansion is prevented by the embedding in the floor, concrete or plaster. The compressive strain and tensile stress arising from this are not critical as they are absorbed by the material itself.

INSTALLATION IN DUCTS

Installation in ducts

Due to the different linear expansion of the aquatherm PP-R-pipes with or without stabilization, the installation of pipe branches in risers has to be made according to the selected type of pipe.

aquatherm blue pipe MF

The linear expansion of aquatherm-faser composite pipes in vertical risers can be ignored.

The positioning of a fixed point directly before each branch-off point is sufficient. All clamps in the riser must be installed as fixed points (see 1).

In general it is possible to install risers rigidly, that means without expansion joints. This directs the expansion on the distance between the fixed points, where it is ineffective.

For a maximum distance between two fixed points please refer pages 76/77.

The installation of risers of aquatherm-pipes without stabilizing components (faser) requires a branch pipe, which is elastic enough to take the linear expansion of the riser.

This can be ensured by a favourable fixing of the riser in the duct (see 2).

An adequate large pipe liner also gives sufficient elasticity to the branch-off pipe (see 3).

Furthermore the installation of a spring leg gives the appropriate elasticity (see 4).

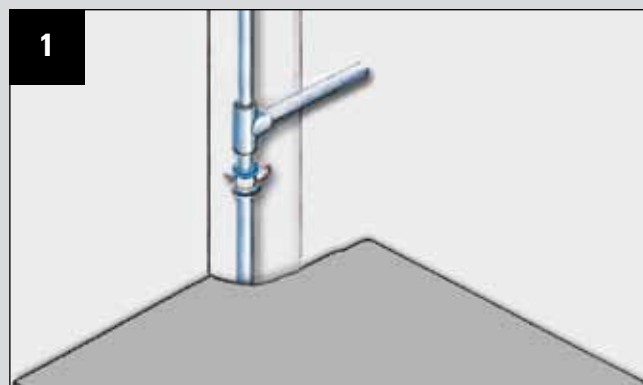

Positioning of the fixed point clamp

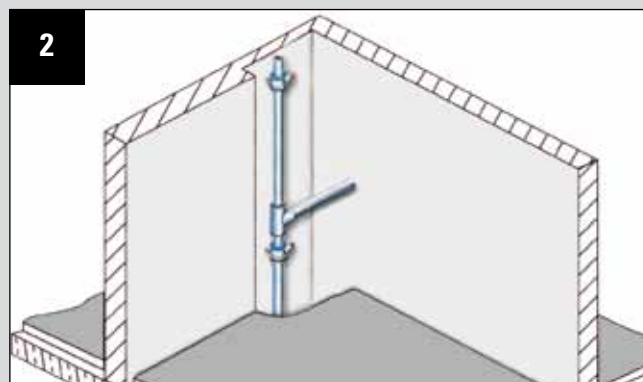

Favourable fixing

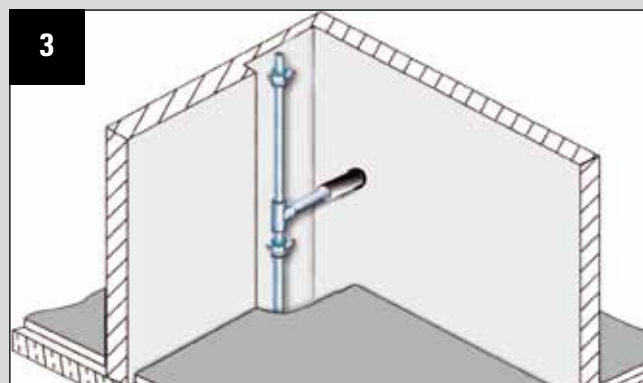

Large diameter pipe liner

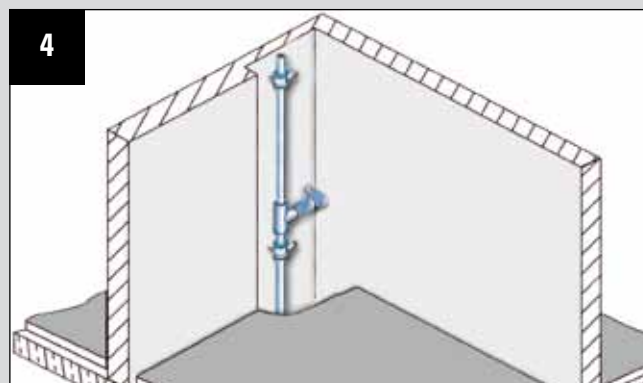

Installation of a spring leg

OPEN INSTALLATION / CALCULATION OF THE LINEAR EXPANSION

Open installation

In case of open installed pipes (e.g. in the basement), excellent optical characteristics and form stability are important. aquatherm-pipes for cold water and aquatherm faser composite pipes for hot water and heating plants make this possible. The coefficient (a) of linear expansion of aquatherm-composite pipes is only

$$\alpha_{\text{green/blue pipe MF}} = 0,035 \text{ mm/mK}$$

and therefore nearly identical with the linear expansion of metal pipes.

The coefficient of linear expansion of aquatherm-pipes without stabilizing components is

$$\alpha_{\text{green/blue pipe}} = 0,150 \text{ mm/mK}$$

aquatherm faser composite pipes must have enough space to expand (see page 68 u. 69). An expansion control must be required for long and straight faser composite pipes (over 40 m).

aquatherm-pipes without the stabilizing compound should have the expansion control after 10 m straight pipelines. Risers of composite pipes may be installed rigidly without expansion compensation. The following formula, calculation examples, data-tables and diagrams help to determine the linear expansion. The difference between working temperature and maximum or minimum installation temperature is essential for the calculation of linear expansion.

Calculation of the linear expansion

Given and required values

Symbol	Meaning	Value	Measuring unit
ΔL	Linear expansion	?	[mm]
α_2	Coefficient of linear expansion aquatherm-faser composite pipe	0,035	mm/mK
α_3	Linear expansion coefficient	0,15	mm/mK
L	Pipe length	25,0	[m]
T_B	Working temperature	60	°C
T_M	Installation temperature	20	°C
ΔT	Temperature difference between working and installation temperature ($\Delta T = T_W - T_M$)	40	K

The linear expansion ΔL is calculated according to the following formula:

$$\Delta L = \alpha \times L \times \Delta T$$

Material:

aquatherm MF-faser composite pipe ($\alpha = 0.03 \text{ mm/mK}$)

$$\Delta L = 0,035 \text{ mm/mK} \times 25,0 \text{ m} \times 40 \text{ K}$$

$$\Delta L = 35,0 \text{ mm}$$

Linear expansion comparison: faser composite to standard PP-pipe

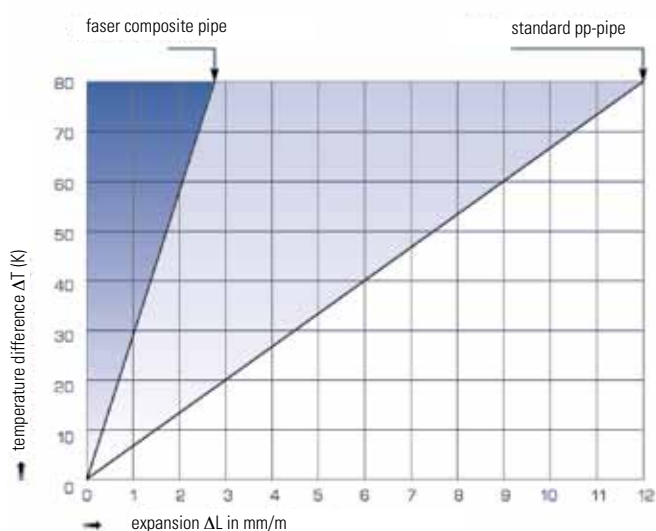

aquatherm blue pipe

(without faser)

The linear expansion, described on the preceding pages, can be taken from the following tables and graphs.

Linear expansion ΔL in [mm]: aquatherm blue pipe - $\alpha = 0,150$ mm/mK

Pipe length	Difference in temperature $\Delta T = T_{\text{operating temperature}} - T_{\text{installation temperature}}$							
	10 K	20 K	30 K	40 K	50 K	60 K	70 K	80 K
	Linear expansion ΔL (mm)							
5 m	8	15	23	30	38	45	53	60
10 m	15	30	45	60	75	90	105	120
15 m	23	45	68	90	113	135	158	180
20 m	30	60	90	120	150	180	210	240
25 m	38	75	113	150	188	225	263	300
30 m	45	90	135	180	225	270	315	360
35 m	53	105	158	210	263	315	368	420
40 m	60	120	180	240	300	360	420	480
45 m	68	135	203	270	338	405	473	540
50 m	75	150	225	300	375	450	525	600

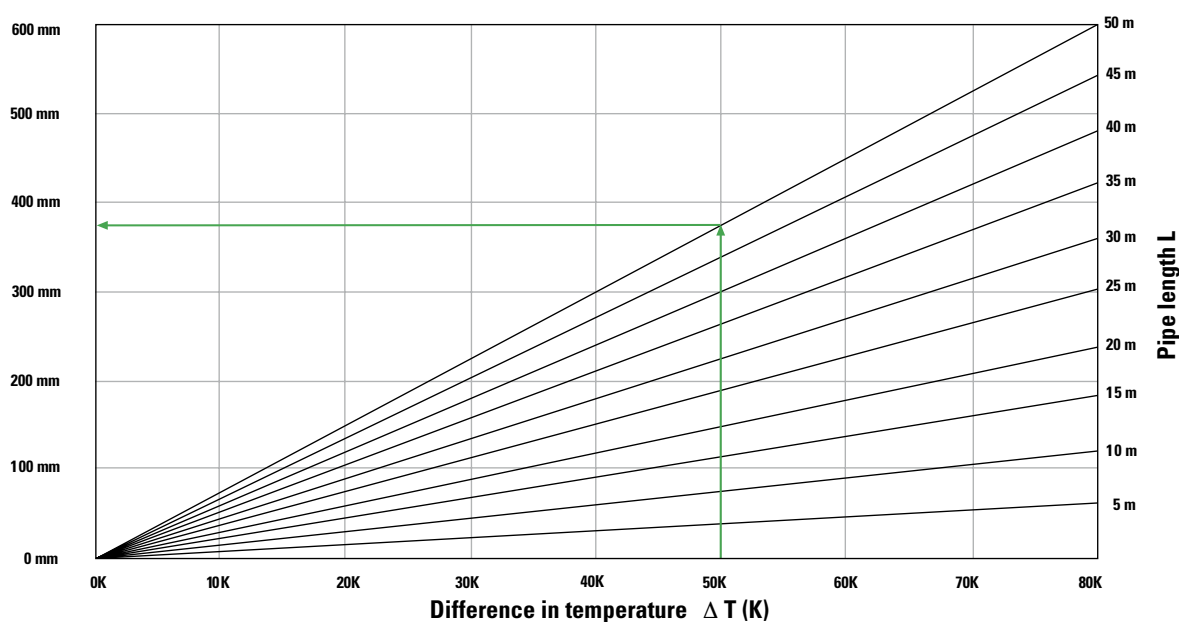

aquatherm blue pipe MF (faser composite pipe)

Due to the integration and positive bond of the different materials, the aquatherm-faser composite pipes offers much higher stability. The linear expansion reduces its value to $\frac{1}{5}$ of the mere PP-pipes.

Linear expansion ΔL in [mm]: aquatherm-faser composite pipes - $a = 0.035 \text{ mm/mK}$

Pipe length	Difference in temperature $\Delta T = T_{\text{operating temperature}} - T_{\text{installation temperature}}$							
	10 K	20 K	30 K	40 K	50 K	60 K	70 K	80 K
	Linear expansion ΔL (mm)							
10 m	4	7	11	14	18	21	25	28
20 m	7	14	21	28	35	42	49	56
30 m	11	21	32	42	53	63	74	84
40 m	14	28	42	56	70	84	98	112
50 m	18	35	53	70	88	105	123	140
60 m	21	42	63	84	105	126	147	168
70 m	25	49	74	98	123	147	172	196
80 m	28	56	84	112	140	168	196	224
90 m	32	63	95	126	158	189	221	252
100 m	35	70	105	140	175	210	245	280

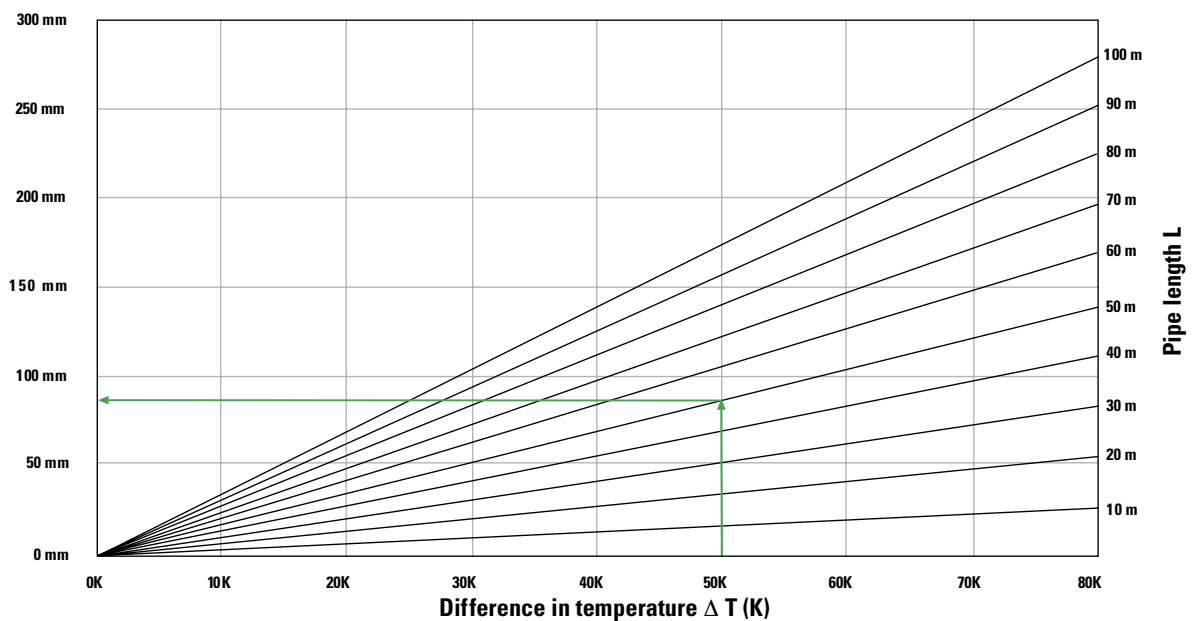

PIPE CLAMPS suitable as fixing point

From now on aquatherm offers fixed-point fastenings for pipes from 160 mm - 630 mm (art.-No. 60768 - 60790). Packing unit is each with 1 piece.

Advantages:

- reliable and permanent protection against perforation corrosion and breakdown of the static load capacity
- 1000 hours salt spray test without ferric oxide (rust)
- suitable for installation in corrosive inner and outside areas
- considerably higher corrosion protection than with electrogalvanized and hot-dip galvanized products (after spread test acc. to DIN EN ISO 9227)

art.-no.	diameter	min. torque clamp locking	min. torque height adjustment	height adjustment	fixig on building	measure „a“	weight per set
[-]	[mm]	[Nm]	[Nm]	[mm]	[-]	[mm]	[kg]
0060768	160	25	75	192,5 - 283,5	M 12	354,1	8,55
0060770	200	25	75	192,5 - 283,5	M 12	394,5	9,45
0060774	250	50	75	192,5 - 283,5	M 12	444,8	19,37
0060778	315	50	75	192,5 - 283,5	M 12	510	22,75
0060780	355	50	75	192,5 - 283,5	M 12	550,1	24,84

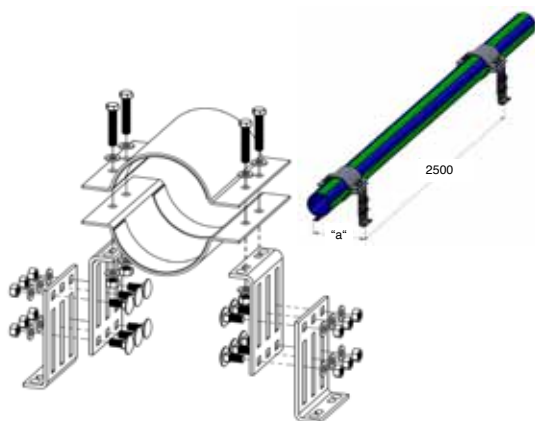

art.-no.	diameter	min. torque clamp locking	min. torque height adjustment	height adjustment	fixig on building	measure „a“	weight per set
[-]	[mm]	[Nm]	[Nm]	[mm]	[-]	[mm]	[kg]
0060782	400	50	120	404,5 - 497,5	M16	823,2	43,64
0060784	450	50	120	404,5 - 497,5	M16	873,3	46,25
0060786	500	50	120	404,5 - 497,5	M16	923,4	48,87
0060788	560	50	120	404,5 - 497,5	M16	983,4	52,00
0060790	630	50	120	404,5 - 497,5	M16	1053,5	55,66

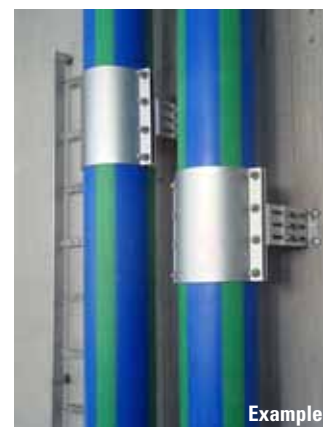
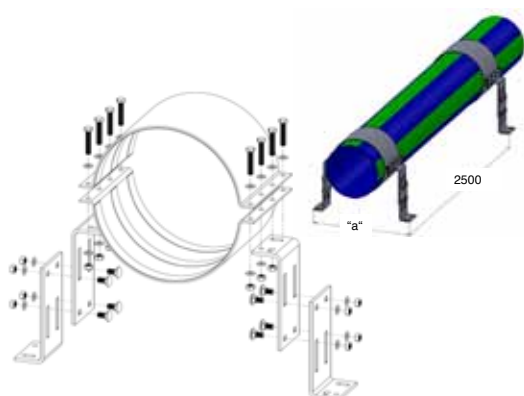

BENDING SIDE

Linear expansion due to temperature difference between operating temperature and installation temperature can be compensated by different installation techniques.

Bending side

In most cases direction changes can be used to compensate for linear expansion in pipes.

The values of the bending side can be taken directly from the tables and graphs on the following pages.

Symbol	Meaning	
L_{BS}	Length of the bending side	[mm]
K	Material specific constant	15,0
d	Outside diameter	[mm]
ΔL	Linear expansion	[mm]
L	Pipe Length	[m]
FP	Fixed point	
GL	Sliding point	

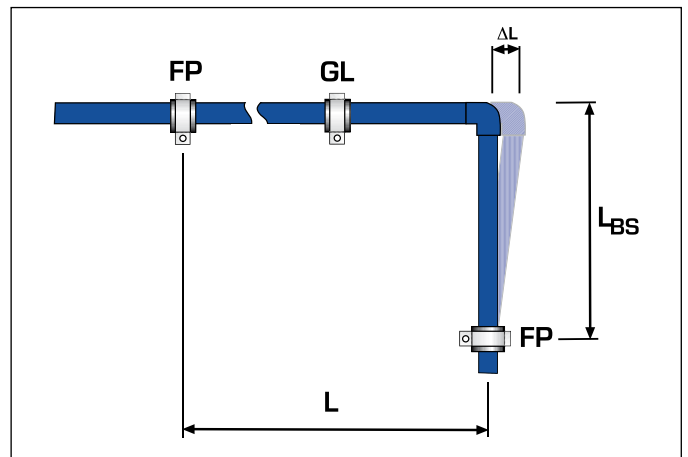

Calculational determination of the bending side length

$$L_{BS} = K \times \sqrt{d \times \Delta L}$$

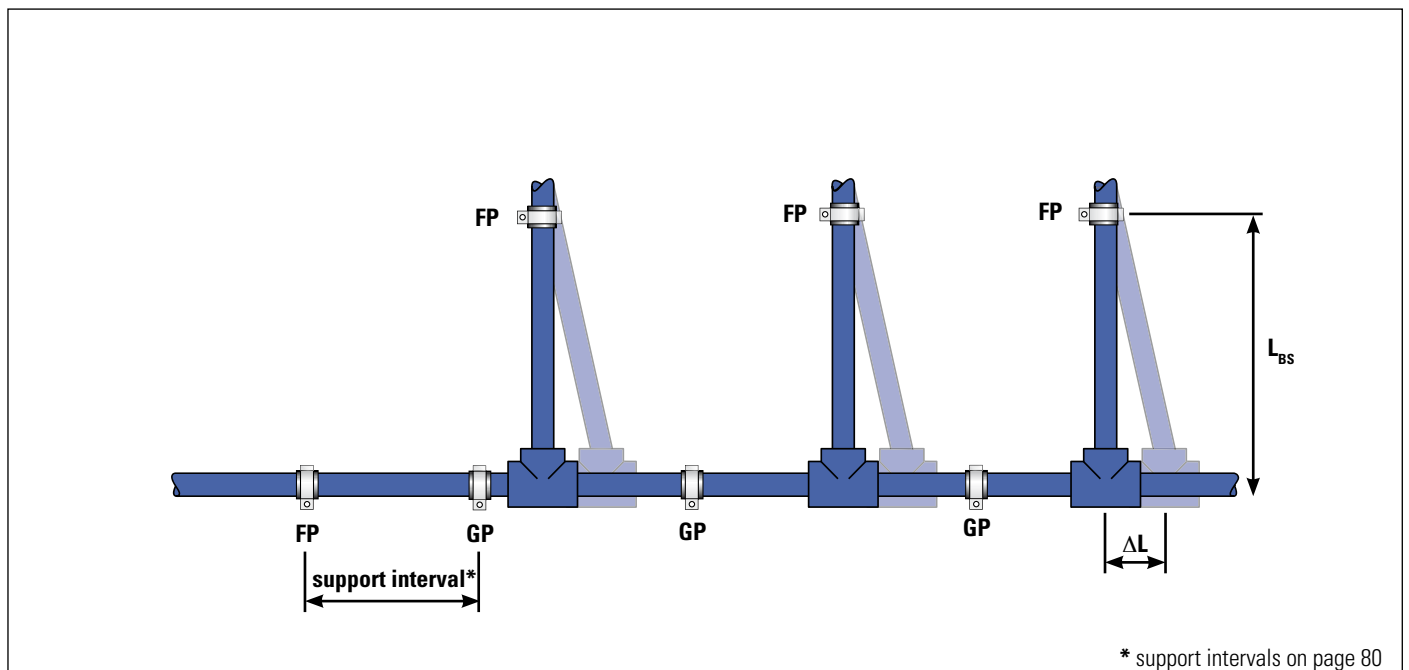

* support intervals on page 80

PRE-STRESS / BELLOW EXPANSION JOINT

Expansion loop

If the linear expansion cannot be compensated by a change in direction, it will be necessary to install an expansion loop with long and straight pipelines.

In addition to the length of the bending side LBS the width of the pipe bend Amin must be considered.

Symbol	Meaning	
A_{min}	Width of the expansion loop	[mm]
SA	Safety distance	150 mm

The pipe bend Amin is calculated acc. to the following formula:

$$A_{min} = 2 \times \Delta L + SA$$

The width of the expansion loop Amin should be at least 210 mm.

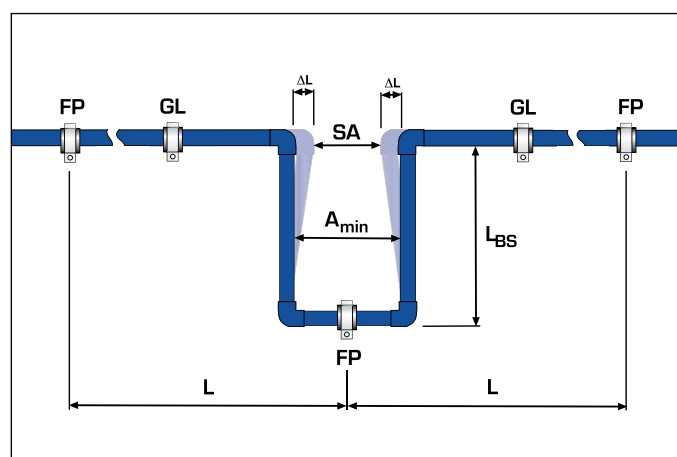

Pre-stress

Where space is limited, it is possible to shorten the total width Amin as well as the length of the bending side LBSV by pre-stressing.

Pre-stress installations, if planned and carried out carefully, offer an optically perfect installation, as the linear expansion is hardly visible.

Symbol	Meaning	
L_{BSV}	Length of pre-stress	[mm]

The side length of expansion loops with pre-stress is calculated acc. to the following example:

$$L_{BSV} = K \times \sqrt{d \times \frac{\Delta L}{2}}$$

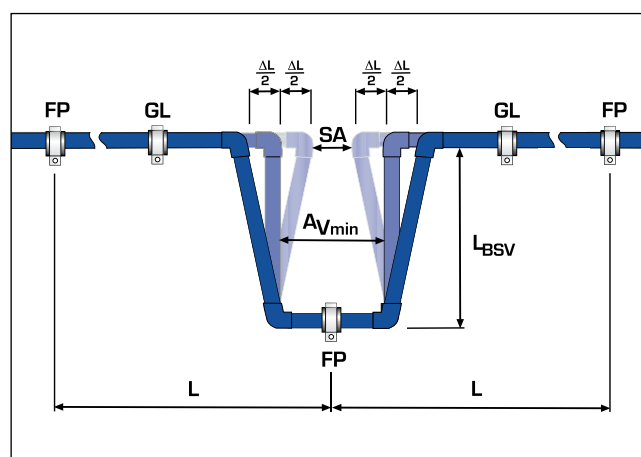

Bellow expansion joint

All bellow expansion joints for corrugated pipes designed for metal materials are unsuitable for aquatherm PP-R-pipes.

When using axial expansion joints observe the manufacturers instructions.

LENGTH OF BENDING SIDE

for aquatherm PP-R pipes The length of the bending side with pre-stress L_{BSV} can be taken from the tables and graphs in consideration of the applied pipe dimensions and determined linear expansion.

Pipe Dimension	Linear expansion (mm)											
	10	20	30	40	50	60	70	80	90	100	110	120
	Length of bending side (mm)											
20 mm	0,21	0,30	0,37	0,42	0,47	0,52	0,56	0,60	0,64	0,67	0,70	0,73
25 mm	0,24	0,34	0,41	0,47	0,53	0,58	0,63	0,67	0,71	0,75	0,79	0,82
32 mm	0,27	0,38	0,46	0,54	0,60	0,66	0,71	0,76	0,80	0,85	0,89	0,93
40 mm	0,30	0,42	0,52	0,60	0,67	0,73	0,79	0,85	0,90	0,95	0,99	1,04
50 mm	0,34	0,47	0,58	0,67	0,75	0,82	0,89	0,95	1,01	1,06	1,11	1,16
63 mm	0,38	0,53	0,65	0,75	0,84	0,92	1,00	1,06	1,13	1,19	1,25	1,30
75 mm	0,41	0,58	0,71	0,82	0,92	1,01	1,09	1,16	1,23	1,30	1,36	1,42
90 mm	0,45	0,64	0,78	0,90	1,01	1,10	1,19	1,27	1,35	1,42	1,49	1,56
110 mm	0,50	0,70	0,86	0,99	1,11	1,22	1,32	1,41	1,49	1,57	1,65	1,72
125 mm	0,53	0,75	0,92	1,06	1,19	1,30	1,40	1,50	1,59	1,68	1,76	1,84
160 mm	0,60	0,85	1,04	1,20	1,34	1,47	1,59	1,70	1,80	1,90	1,99	2,08
200 mm	0,67	0,95	1,16	1,34	1,50	1,64	1,77	1,90	2,01	2,12	2,22	2,32
250 mm	0,75	1,06	1,30	1,50	1,68	1,84	1,98	2,12	2,25	2,37	2,49	2,60
315 mm	0,84	1,19	1,46	1,68	1,88	2,06	2,23	2,38	2,53	2,66	2,79	2,92
355 mm	0,89	1,26	1,55	1,79	2,00	2,19	2,36	2,53	2,68	2,83	2,96	3,10
400 mm	0,95	1,34	1,64	1,90	2,12	2,32	2,51	2,68	2,85	3,00	3,15	3,29
450 mm	1,01	1,42	1,74	2,01	2,25	2,46	2,66	2,85	3,02	3,18	3,34	3,49
500 mm	1,06	1,50	1,84	2,12	2,37	2,60	2,81	3,00	3,18	3,35	3,52	3,67
560 mm	1,12	1,59	1,94	2,24	2,51	2,75	2,97	3,17	3,37	3,55	3,72	3,89
630 mm	1,19	1,68	2,06	2,38	2,66	2,92	3,15	3,37	3,57	3,76	3,95	4,12

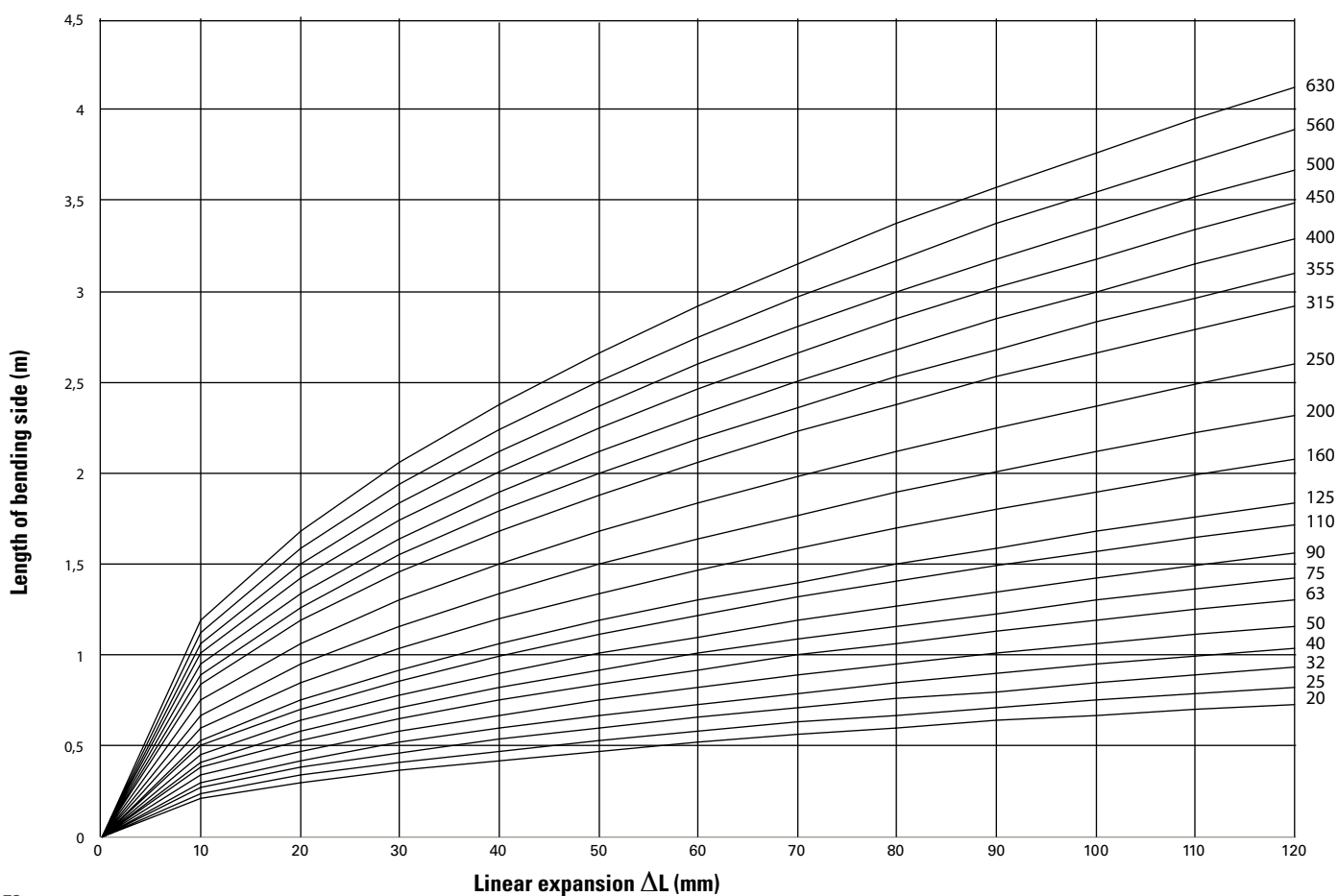

LENGTH OF BENDING SIDE WITH PRE-STRESS

for aquatherm PP-R pipes The length of the bending side with pre-stress L_{BSV} can be taken from the tables and graphs in consideration of the applied pipe dimensions and determined linear expansion.

Pipe Dimension	Linear expansion (mm)											
	10	20	30	40	50	60	70	80	90	100	110	120
	Length of bending side (mm)											
20 mm	0,15	0,21	0,26	0,30	0,34	0,37	0,40	0,42	0,45	0,47	0,50	0,52
25 mm	0,17	0,24	0,29	0,34	0,38	0,41	0,44	0,47	0,50	0,53	0,56	0,58
32 mm	0,19	0,27	0,33	0,38	0,42	0,46	0,50	0,54	0,57	0,60	0,63	0,66
40 mm	0,21	0,30	0,37	0,42	0,47	0,52	0,56	0,60	0,64	0,67	0,70	0,73
50 mm	0,24	0,34	0,41	0,47	0,53	0,58	0,63	0,67	0,71	0,75	0,79	0,82
63 mm	0,27	0,38	0,46	0,53	0,60	0,65	0,70	0,75	0,80	0,84	0,88	0,92
75 mm	0,29	0,41	0,50	0,58	0,65	0,71	0,77	0,82	0,87	0,92	0,96	1,01
90 mm	0,32	0,45	0,55	0,64	0,71	0,78	0,84	0,90	0,95	1,01	1,06	1,10
110 mm	0,35	0,50	0,61	0,70	0,79	0,86	0,93	0,99	1,06	1,11	1,17	1,22
125 mm	0,38	0,53	0,65	0,75	0,84	0,92	0,99	1,06	1,13	1,19	1,24	1,30
160 mm	0,42	0,60	0,73	0,85	0,95	1,04	1,12	1,20	1,27	1,34	1,41	1,47
200 mm	0,47	0,67	0,82	0,95	1,06	1,16	1,25	1,34	1,42	1,50	1,57	1,64
250 mm	0,53	0,75	0,92	1,06	1,19	1,30	1,40	1,50	1,59	1,68	1,76	1,84
315 mm	0,60	0,84	1,03	1,19	1,33	1,46	1,58	1,68	1,79	1,88	1,97	2,06
355 mm	0,63	0,89	1,09	1,26	1,41	1,55	1,67	1,79	1,90	2,00	2,10	2,19
400 mm	0,67	0,95	1,16	1,34	1,50	1,64	1,77	1,90	2,01	2,12	2,22	2,32
450 mm	0,71	1,01	1,23	1,42	1,59	1,74	1,88	2,01	2,13	2,25	2,36	2,46
500 mm	0,75	1,06	1,30	1,50	1,68	1,84	1,98	2,12	2,25	2,37	2,49	2,60
560 mm	0,79	1,12	1,37	1,59	1,77	1,94	2,10	2,24	2,38	2,51	2,63	2,75
630 mm	0,84	1,19	1,46	1,68	1,88	2,06	2,23	2,38	2,53	2,66	2,79	2,92

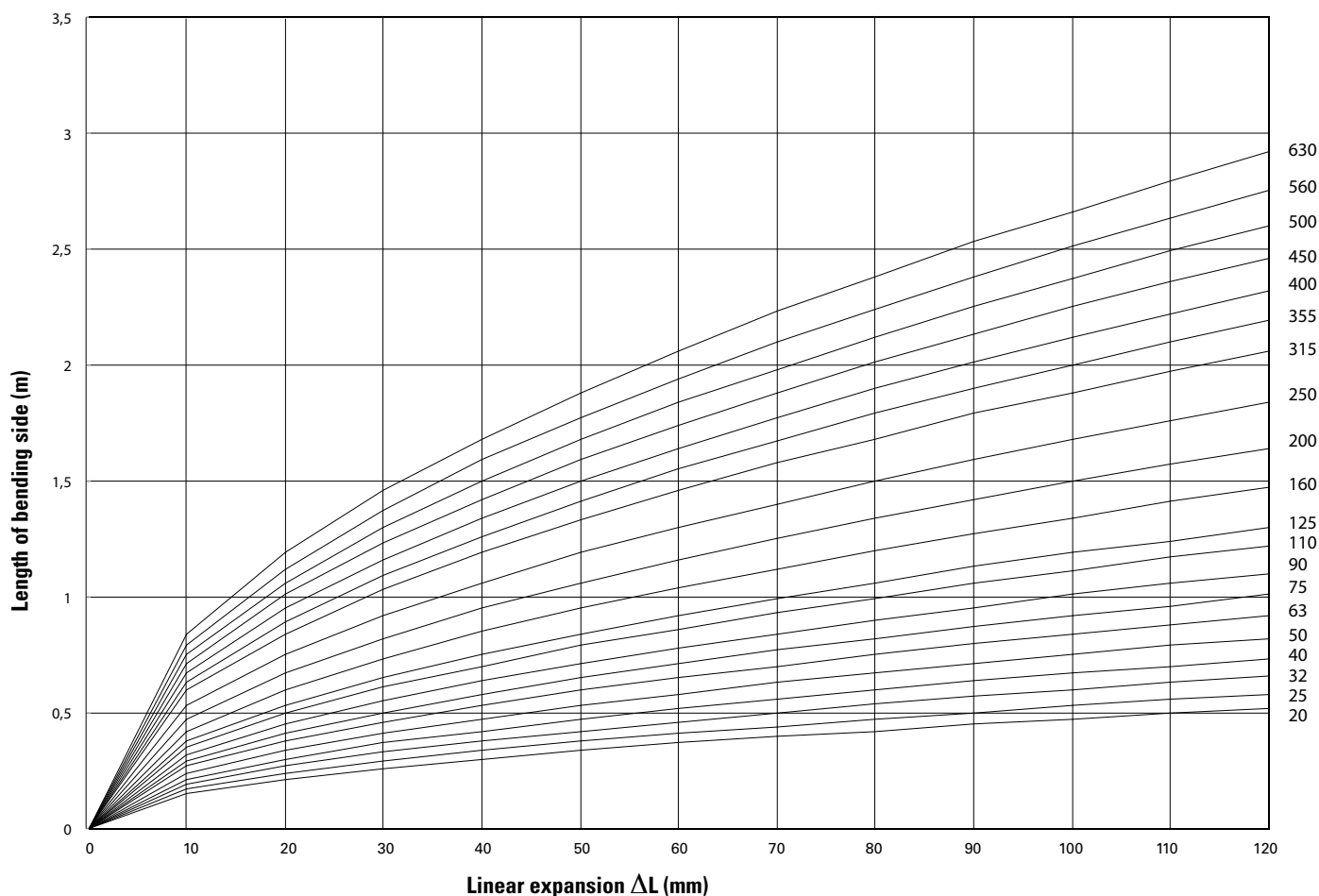

SUPPORT INTERVALS

aquatherm blue pipe SDR 11 S

Table to determine support intervals in conjunction with temperature and outside diameter.

Pipe diameter d (mm)		
20	25	32
Support intervals in cm		
60	75	90

aquatherm blue pipe SDR 17,6 MF

Table to determine support intervals in conjunction with temperature and outside diameter.

Difference in temperature ΔT [K]	Pipe diameter d (mm)										
	125	160	200	250	315	355	400	450	500	560	630
	Support intervals in cm										
0	255	260	265	275	280	285	295	305	315	325	330
20	185	190	200	205	210	215	230	240	255	270	280
30	175	180	190	195	200	205	220	230	245	260	275
40	170	175	180	190	190	195	210	225	235	250	265
50	160	165	175	180	185	190	200	215	230	240	255
60	150	155	165	170	175	180	185	200	215	230	240
70	140	145	155	160	170	175	180	190	205	220	230

aquatherm blue pipe SDR 7,4 MF (faser composite pipe)

Table to determine support intervals in conjunction with temperature and outside diameter.

Difference in temperature ΔT [K]	Pipe diameter d (mm)		
	20	25	32
	Support intervals in cm		
0	120	140	160
20	90	105	120
30	90	105	120
40	85	95	110
50	85	95	110
60	80	90	105
70	70	80	95

SUPPORT SPACINGS PP-PIPE AND FASER COMPOSITE PIPE

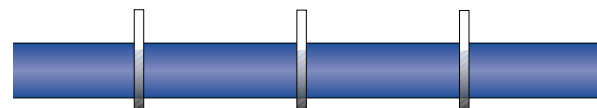

PP-pipe

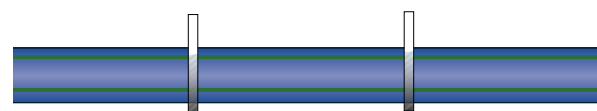

Faser composite pipe approx. 30% more fixing distance

aquatherm blue pipe SDR 11 MF (faser composite pipe)

Table to determine support intervals in conjunction with temperature and outside diameter.

Difference in temperature ΔT [K]	Pipe diameter d (mm)																
	20	25	32	40	50	63	75	90	110	125	160	200	250	315	355	400	450
	Support intervals in cm																
0	110	130	150	170	195	220	235	250	275	280	285	290	300	310	315	325	325
20	80	95	110	125	145	165	175	185	200	205	210	220	225	230	235	250	265
30	80	95	110	125	145	165	175	185	190	195	200	210	215	220	225	240	255
40	75	85	100	115	135	155	165	175	180	185	190	200	210	210	215	230	245
50	75	85	100	115	135	155	160	170	170	175	180	190	200	205	205	220	235
60	70	80	95	110	125	145	150	160	160	165	170	180	185	190	195	205	220
70	60	70	85	100	120	135	140	145	150	155	160	170	175	185	190	195	210

Pipe clamp distances of vertically installed pipes can be increased by 20 % of the tabular values, e.g. to multiply the tabular value by 1.2.

THERMAL INSULATION OF HOT WATER PIPES
minimum insulation thickness in [mm] against condensation

MEDIUM TEMPERATURE 5°C - THERMAL CONDUCTIVITY VALUE OF INSULATION 0,040W/MK												
Dimension	humidity	ambient temperature										
		20°C	22°C	24°C	26°C	28°C	30°C	32°C	34°C	36°C	38°C	40°C
75mm	50%		1	1	2	2	3	3	4	4	5	5
	60%	2	3	3	4	5	5	6	7	7	8	8
	70%	5	6	7	8	8	9	10	11	12	13	13
	80%	9	11	12	14	15	17	18	19	20	21	22
110mm	50%				1	2	2	3	3	4	4	4
	60%	1	2	3	3	4	5	5	6	7	7	8
	70%	4	5	6	7	8	9	10	10	11	12	13
	80%	9	11	12	14	15	17	18	19	20	21	22
160mm	50%						1	1	2	2	3	3
	60%		1	1	2	3	4	4	5	5	6	7
	70%	3	4	5	6	7	8	9	9	11	11	12
	80%	8	10	11	13	14	16	17	19	20	21	22

The decree for energy saving thermal protection and energy saving technique for buildings Decree for Energy Saving (EnEV) regulates the thermal insulation of hot water supplies and fittings in Germany.

Central heating pipes, line 1-4 installed in heated rooms or building parts between heated rooms of the one user, where heat output can be controlled by open stop valves do not require a minimum thickness of the insulation.

This even applies to hot water pipes up to an inner diameter of 22 mm in flats, which are neither in the circulation nor have an additional electric heating.

Applying material with thermal conductivities different to 0.035 W/(mK) the minimum thickness of the insulation has to be converted correspondingly.

For the conversion and the thermal conductivity of the insulation the ways and values of calculation described in the technical regulations must be applied.

The minimum insulation acc. to the table for heating distributions and heating pipes can be reduced as far as the same limit of heat output even for further insulation requirements in consideration of the insulating effect of the pipe walls are guaranteed.

EnEV 2009, § 14, addendum 5, chart 1

Line	Type of pipe/fitting	minimum thickness of insulation referred to thermal conductivity of 0.035 W/(mK)
1	inner diameter up to 22 mm	20 mm
2	inner diameter more than 22 mm up to 35 mm	30 mm
3	inner diameter more than 35 mm up to 100 mm	same as inner diameter
4	inner diameter more than 100 mm	100 mm
5	pipes and fittings after line 1-4 in wall- and ceiling openings, in crossing area of pipes, at pipe connections, at distributors	½ of the requirements of line 1 to 4
6	pipes of central heating after line 1-4, which have been installed after introduction of this decree between heated rooms of various users	½ of the requirements of line 1 to 4
7	pipes after line 6 in floor construction	6 mm
8	Cooling distribution and cold water pipes and fittings of air handling and air conditioning systems	6 mm

INSULATION THICKNESS ACC. TO DECREE FOR ENERGY SAVING

Acc. to this decree aquatherm PP-R-pipes and fittings have to be insulated against loss of heat. The insulation thickness depends on the respective installation.

The heat conductivity figure of fusiolen® PP-R is 0.15 W/(mK) aquatherm PP-R-pipes and fittings offer a significantly higher degree of insulation compared to metal pipes.

Due to the high insulation values of the pipe-material PP-R the insulation thickness - compared to metallic pipe systems - can be reduced.

Undermentioned are the recommendation based on EnEV 2009. Regional standards might vary and are to be considered.

Thermal insulation from heat distribution and hot water pipes, cooling distribution and cold water pipes acc. EnEV 2009

Minimum thickness of insulation referred to thermal conductivity of 0.035 W/(mK)

pipe diameter	50%	100%
16 mm	10 mm	20 mm
20 mm	10 mm	20 mm
25 mm	10 mm	20 mm
32 mm	15 mm	30 mm
40 mm	15 mm	30 mm
50 mm	18 mm	35 mm
63 mm	23 mm	45 mm
75 mm	28 mm	55 mm
90 mm	33 mm	65 mm
110 mm	40 mm	80 mm
125 mm	45 mm	90 mm
160 mm	50 mm	100 mm
200 mm	50 mm	100 mm
250 mm	50 mm	100 mm
315 mm	50 mm	100 mm
355 mm	50 mm	100 mm
400 mm	50 mm	100 mm
450 mm	50 mm	100 mm
500 mm	50 mm	100 mm
560 mm	50 mm	100 mm
630 mm	50 mm	100 mm

* The insulation thickness has to be calculated due to the thermal conductivity of polypropylene pipes acc. to test report no.: G.2 - 136/97 of FIW-Munich

PRESSURE TEST / TEST CONTROL / MEASURING OF THE TEST PRESSURES / TEST RECORD

Pressure test / Test control

All aquatherm pipe systems shall be subjected to a hydraulic pressure test with a test-pressure of 10 bar.

The material properties of the aquatherm pipe systems result in an expansion of the pipes during the pressure test. This affects the test result. Due to the thermal expansion coefficients of the aquatherm pipe systems the results are influenced additionally. The temperature differences between the pipe and the test medium lead to changes in pressure. Hereby a temperature change of 10 K corresponds to a pressure difference of 0,5 up to 1 bar.

Therefore pressure testing of the aquatherm pipe systems should be made with a constant temperature of the test medium. The hydraulic pressure test requires a preliminary, principal and final test.

In the preliminary test a pressure of 18 bar is applied 3 x 5 minutes for the expansion/release of the pipes. Between the cycles the pipe system must be depressurized.

Immediately after the preliminary test the principal test should be performed. The test duration is 15 min. Here, the test pressure (10 bar) may not fall more than 0,5 bar.

After completion of the preliminary and principle test finally the final test must be performed.

The test duration is 60 minutes. Here, the test pressure - read after the principle test - may not fall more than 0,5 bar.

Measuring of the test pressures

Measuring has to be done with a manometer allowing a perfect reading of a pressure change of 0.1 bar. The manometer has to be placed at the deepest point of the installation.

Test record

A record of the hydraulic pressure test has to be prepared and signed by the client and contractor stating place and date (see page 85).

LEAKAGE TEST / PRESSURE DIAGRAM

PRELIMINARY TEST

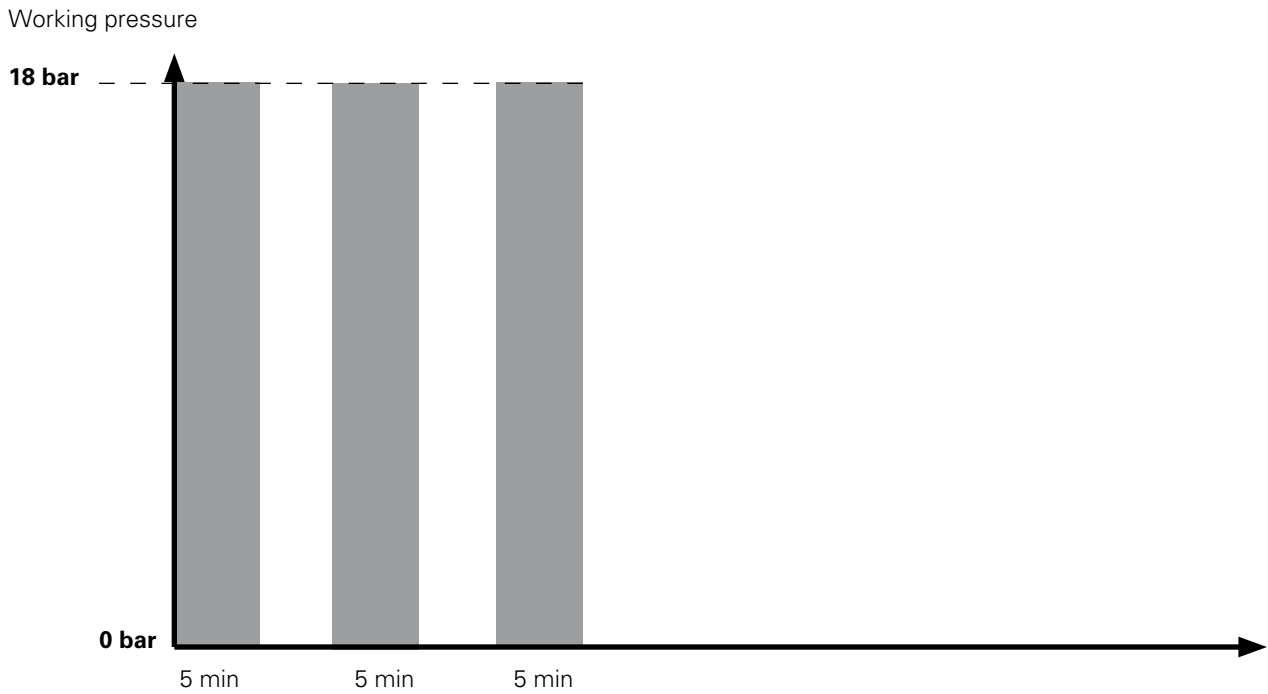

PRINCIPAL- AND FINAL TEST

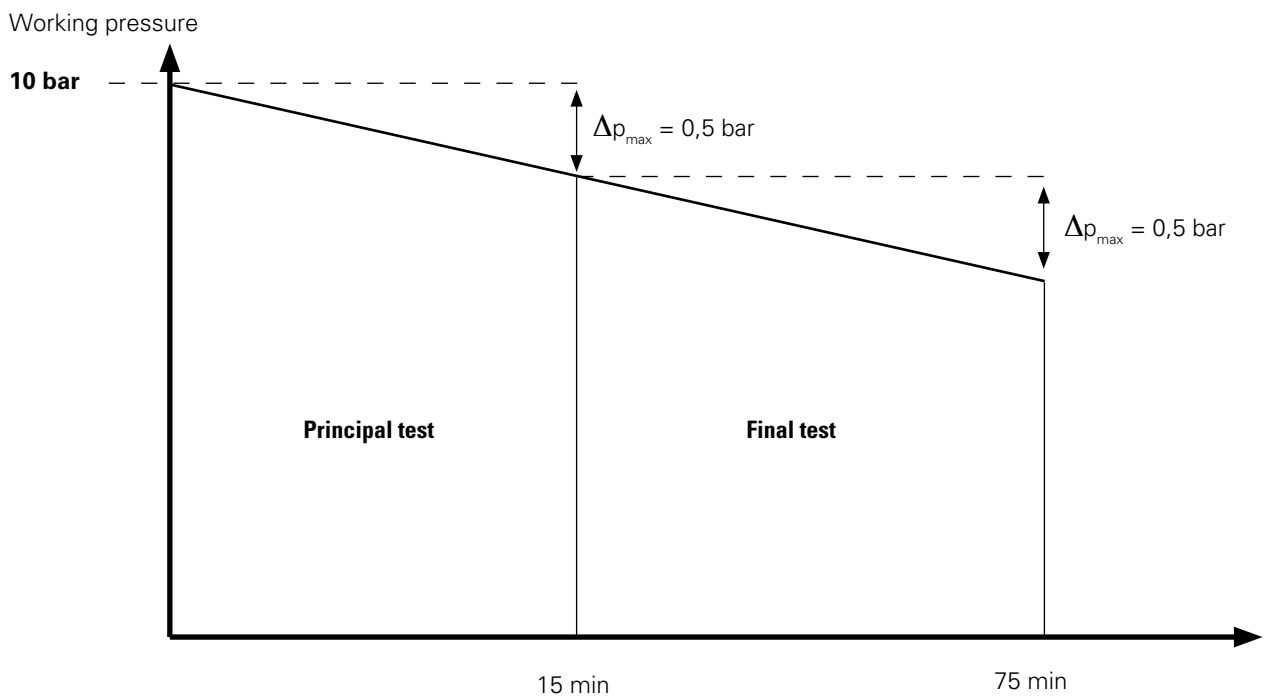

TEST RECORD AQUATHERM SYSTEM INSTALLATION

Place: _____

Object: _____

Note before the test:

3 x 5 minutes system pressure of 18 bar for expansion/release of the pipes are required.

Preliminary test

The pipe system must be unpressurized between each cycle.

18 bar	5 min	realized:	yes	no
18 bar	5 min	realized:	yes	no
18 bar	5 min	realized:	yes	no

Principal test

Test pressure: _____ 10 _____ bar

Pressure decline after 15 min: _____ bar **max. 0,5 bar**

Final test

(directly after the principal test, without changing the pressure)

Result principal test: _____ bar

Pressure decline after 60 min: _____ bar **max. 0,5 bar**

Notes: _____

Place: _____

Date: _____

Stamp / Signature

Description of installation

Place: _____

Object: _____

Pipe length:

Ø 20 mm	_____	m	Ø 160 mm	_____	m
Ø 25 mm	_____	m	Ø 200 mm	_____	m
Ø 32 mm	_____	m	Ø 250 mm	_____	m
Ø 40 mm	_____	m	Ø 315 mm	_____	m
Ø 50 mm	_____	m	Ø 355 mm	_____	m
Ø 63 mm	_____	m	Ø 400 mm	_____	m
Ø 75 mm	_____	m	Ø 450 mm	_____	m
Ø 90 mm	_____	m	Ø 500 mm	_____	m
Ø 125 mm	_____	m	Ø 560 mm	_____	m
			Ø 630 mm	_____	m

Start of test: _____

End of test: _____

Testperiod: _____

Test medium: water water/glycol

Client: _____













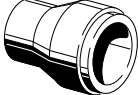
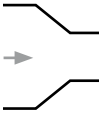

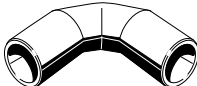

Contractor: _____

Place: _____

Date: _____

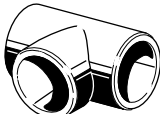
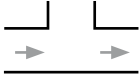

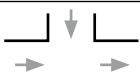
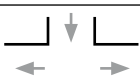
Stamp / Signature

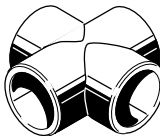
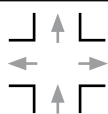
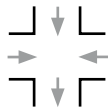
Coefficient of loss ζ aquatherm green pipe- & aquatherm blue pipe-fittings

Fitting	Picture	Symbol	Comment	ζ -Value
Socket				0.25
Reducer			Reduction...	
			...by 1 dimension	0.40
			...by 2 dimension	0.50
			...by 3 dimension	0.60
			...by 4 dimension	0.70
			...by 5 dimension	0.80
...by 6 dimension	0.90			
Elbow 90°				1.20
Segment elbow 90° (200 - 630 mm)				0,80
Elbow 90° male/female				1.20
Elbow 45°				0.50
Elbow 45° male/female				0.50
Tee				0.25
			Separation of flow	1.20
			Conjunction of flow	0.80
			Counter current in case of separation of flow	1.80
			Counter current in case of conjunction of flow	3.00
Reducing tee	The ζ -value results from the addition of tee and reducer			
Cross			Separation of flow	2.10
			Conjunction of flow	3.70



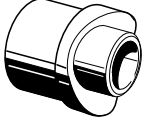
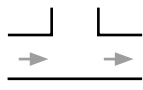
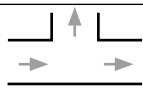
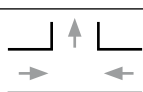
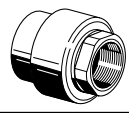
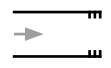
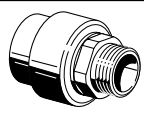

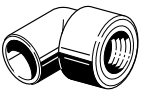
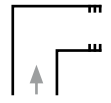
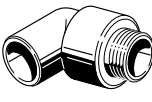
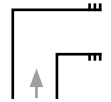
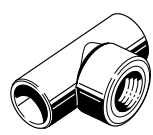
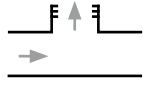
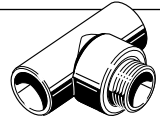
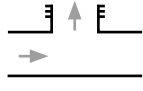

(\rightarrow = flow direction)

Coefficient of loss ζ aquatherm green pipe- & aquatherm blue pipe-fittings

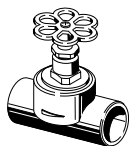
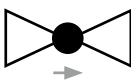
Fitting	Picture	Symbol	Comment	ζ -Value
Weld-in saddle				0.25
			Separation of flow	0.5
			Counter current in case of conjunction of flow	1.00
Reducing tee	The ζ -value results from the addition of the weld in saddle and tee			
Transition piece with female thread				0.50
Transition piece with male thread				0.70
Elbow with female thread				1.40
Elbow with male thread				1.60
Transition tee with female thread			Separation of flow	
			- 16 x 1/2" x 16 - 20 x 3/4" x 20	1.40
			- 20 x 1/2" x 20 - 25 x 3/4" x 25 - 32 x 1" x 32	1.60
			- 25 x 1/2" x 25 - 32 x 3/4" x 32	1.80
Threaded branch tee with male thread			Separation of flow - 20 x 1/2" x 20	1.80

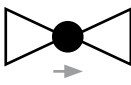
(→ = flow direction)

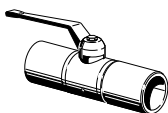
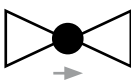
Coefficient of loss ζ aquatherm green pipe- & aquatherm blue pipe-fittings

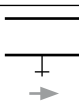
Fitting	Picture	Symbol	Comment	K_v
Screw-down stop globe valve			- 20 mm	
			- 25 mm	
			- 32 mm	
			- 40 mm	
Inclined valve			- 20 mm	
			- 25 mm	
			- 32 mm	
			- 40 mm	
Non-return valve			- 20 mm	
			- 25 mm	
			- 32 mm	
			- 40 mm	
Ball valve			- 20 mm	
			- 25 mm	
			- 32 mm	
			- 40 mm	
			- 50 mm	
Draining branch				

(→ = flow direction)

Source: DIN 1988 Part 3

$$Z = \frac{\zeta v^2 \delta}{2}$$

Z = Pressure lost in [Pa]

ζ = Coefficient of loss of fitting

v = Flow rate [m/s]

δ = Density of medium [kg/m³]

(K_v = Cold Water Volume Rate circulatory [m³/h] of water [5 °C - 30 °C] at a pressure difference of 1 bar)

Note:

For the determination of pressure loss in (mbar) the result has to be divided by the factor 100 (100Pa = 1 mbar).

1bar = 10⁵ Pa = 14,5 psi = 10 N/cm²)

CHEMICAL RESISTANCE OF PIPES AND FITTINGS

The following chemical resistance document can be used as a general guideline, but should not be considered a formal recommendation or approval by aquatherm. The actual behavior of the piping system when exposed to a specific chemical is very dependent on the exposure conditions (temperature, pressure, flow, duration, etc.), the stresses on the piping material and system (mechanical, thermal, cyclic, etc.), and the ancillary materials in the system (o-rings, seals, gaskets, metal components, etc). Due to the comprehensive warranty provided by aquatherm, specific applications must be submitted to aquatherm for review and evaluation using the form in the technical catalog or the online submittal form. A written response will be provided once the review is completed. The attached guidance document should NOT be used as a definitive reference for determining the chemical compatibility of aquatherm piping in a specific application. This can only be determined by submitting the information to aquatherm for review.

Polypropylene (PP) pipes; chemical resistance of pipes and pipe fittings.

The behavior of pipes and pipe fittings towards flow substances depends on the one hand on the particular nature and type of plastic, the design of the pipe fitting and the manufacturing conditions, and, on the other hand, on the nature of the flow substance. In particular, the duration of the action, temperatures and mechanical stresses acting at the same time and other types of influences which additionally have an effect also determine the behavior. The effects of these influences, which frequently are not clearly foreseeable at the outset, are decisive for the suitability for an application. Furthermore, special requirements on the pipe or pipe fitting (e.g. dimensional stability or mechanical strength) shall be taken into consideration, depending on the application.

For these reasons, the suitability of pipes and pipe fittings for a flow substance can be evaluated only from case to case.

The chemical resistance indicates the gradual behavior of the material of the pipe wall towards the action of the flow substance. It depends in each case on the type of interacting substances, their composition, the temperature and the duration of the action.

In an application, the chemical resistance can be influenced by further stresses (e.g. of a mechanical nature).

Note: The chemical resistance does not correspond to the term "chemical stability" hitherto used in everyday language, because this contains an evaluation for the particular application.

Data on chemical resistance

Various processes may occur when the flow substances come into contact with the material of the pipe wall, such as absorption of the liquid (swelling), extraction of soluble constituents of the material (shrinkage) and chemical reactions (hydrolysis, oxidation and the like), which in certain circumstances may cause changes in the properties of the pipes and pipe fittings.

The behavior of the pipes and pipe fittings towards the flow substances is classified into the following groups:

- : **resistant**
The material of the pipe wall is generally evaluated as suitable.
- ◐: **conditionally resistant**
The suitability of the material of the pipe wall for the particular application shall be investigated; if necessary, further experiments shall be carried out.
- : **not resistant**
The material of the pipe wall is generally evaluated as unsuitable.
- : No data on the chemical resistance is available

Information on resistance can also be obtained from the aqualab:

Hotline +49 2722- 950-0

For inquiries on resistance, medium and operating conditions (operating pressure and temperature) needs to be specified.

¹⁾ Table taken from the English translation of DIN 8078 Supplement 1, Feb. 1982, Chemical resistance of (PP-) pipes and pipe fittings. Reproduction with the permission of DIN Deutsches Institut für Normung e. V.. Important: When applying said standard the edition with the most recent release date should be used (can be purchased at Beuth Verlag GmbH, Burggrafenstrasse 6, 10787 Berlin, Germany).

¹⁾ The following designations are used for the composition of the flow substances:

a) If the content data is not followed by "(Vol.)", the data is the weight in % (previously % by weight) .

VL: aqueous solution, the weight content of which is ≤ 10%.

L: aqueous solution, the weight content of which is greater than 10%.

GL: saturated (at 20 °C) aqueous solution.

TR: flow substance is as least technically pure.

H: commercially available composition.

b) Volume content in % (previously % by volume): this is characterized specially by "(Vol)".

The chemical resistance of pipes and pipe fittings is generally not reduced for weight or volume contents and temperatures lower than those given in the table.

²⁾ These flow substances and/or chemical resistance data are not contained in ISO/TR 7471.

³⁾ The chemical resistance is evaluated as one group lower in ISO/TR 7471.

⁴⁾ The chemical resistance is evaluated as one group higher in ISO/TR 7471.

Flow Substance	Content ¹⁾ %	Behavior at		
		20°C / 68 °F	60°C / 140 °F	100°C / 212 °F
Waste gases ²⁾ or air/gas mixtures				
- containing hydrogen fluoride	traces	●	●	–
- containing carbon dioxide	any	●	●	–
- containing carbon monoxide	any	●	●	–
- containing nitroses (nitrogen oxide)	traces	●	●	–
- containing hydrochloric acid	any	●	●	–
- containing sulphur dioxide	any	●	●	–
- containing sulphuric acid	any	●	●	–
- containing sulphur: trioxide (oleum)	traces	○	○	○
Acetaldehyde ²⁾	TR	◐	–	–
Acetaldehyde, aqueous ²⁾	40%	●	●	–
Acetic anhydric (acetic acid anhydride)	TR	●	–	–
Acetone	TR	●	●	–
Acetophenone	TR	●	◐	–
Acrylonitrile	TR	●	● ²⁾	–
Adipic acid ²⁾	GL	●	●	–
Malic acid	L	●	●	–
Caustic soda see sodium hydroxide solution	up to 60%	●	●	●
Battery acid ²⁾	H	●	●	–
Alums (Me(I)-Me(III)-sulphates) ²⁾	GL	●	●	–
Allyl alcohol (prop-2-en-1-ol), aqueous ²⁾	96%	●	●	–
Aluminium chloride ²⁾	GL	●	●	–
Aluminium sulphate ²⁾	GL	●	●	–
Formic acid, aqueous	10%	●	●	◐
Formic acid, aqueous	85%	●	◐ ³⁾	○
2 - Aminoethanol (ethanolamine)	TR	●	–	–
Ammonia, liquid	TR	●	–	–
Ammonia, gaseous	TR	●	● ²⁾	–
Aqueous ammonia (ammonia solution)	GL	●	● ²⁾	–
Ammonium acetate	GL	●	●	–
Ammonium carbonate ²⁾ and bicarbonate	GL	●	●	–
Ammonium chloride	GL	●	● ²⁾	–
Ammonium fluoride	L	●	●	–
Ammonium nitrate	GL	●	●	●
Ammonium phosphate ²⁾	GL	●	●	●
Ammonium sulphate	GL	●	●	●
Ammonium sulphide ²⁾	GL	●	●	–
Amyl acetate (acetate (acetic acid isoamyl ester)	TR	◐	–	–
Amyl alcohol (fermentation amyl alcohol)	TR	●	●	●
Aniline	TR	◐ ⁴⁾	◐ ⁴⁾	–
Anilium chloride (aniline hydrochloride)	GL	●	●	–
Anisole ²⁾	TR	◐	◐	–
Anone see cyclohexanone	TR	◐	○	○
Antimony(III) chloride, aqueous ²⁾	90%	●	●	–
Apple juice	H	●	● ²⁾	● ²⁾

Flow Substance	Content ¹⁾ %	Behavior at		
		20°C / 68 °F	60°C / 140 °F	100°C / 212 °F
Malic acid	L	●	●	–
Apple wine ²⁾	H	●	●	–
Arsenic acid, ortho, aqueous ²⁾	10%	●	●	–
Arsenic acid, ortho, aqueous ²⁾	80%	●	●	◐
Barium hydroxide	GL	●	●	●
Barium salts ²⁾	GL	●	●	●
Cottonseed oil	TR	●	●	–
Benzaldehyde ²⁾	GL	●	●	–
Benzaldehyde ²⁾	L	●	–	–
Benzine (aliphatic hydrocarbons)	H	◐ ³⁾	○	○
Benzine/benzene mixture ²⁾	80%/20% (Vol.)	◐	○	○
Benzoic acid	GL	●	● ²⁾	–
Benzene	TR	◐	○	○
Benzoyl chloride ²⁾	TR	◐	–	–
Benzyl alcohol	TR	●	◐	–
Succinic acid	GL	●	●	–
Beeswax ²⁾	H	●	◐	–
Beer ²⁾	H	●	●	●
Caramel ²⁾	VL	●	●	–
Hydrocyanic acid ²⁾ (hydrogen cyanide)	TR	●	●	–
Lead acetate ²⁾	GL	●	●	◐
Bleaching liquor (sodium hypochlorite)	20%	◐ ⁴⁾	◐	○ ²⁾
Lead tetraethyl (tetraethyl-lead) ²⁾	TR	●	–	–
Borax (sodium tetraborate)	L	●	●	–
Boric acid	GL	●	● ²⁾	● ²⁾
All types of spirits ²⁾	H	●	●	–
Bromine (bromine water) ²⁾	GL	◐	○	○
Bromine, gaseous	any	◐	○	○
Bromine, liquid	TR	○	○	○
Bromomethyl see methyl bromide	TR	○	○	○
Hydrobromic acid, aqueous	48%	●	◐	○
Butane, gaseous	TR	●	● ²⁾	–
Butadiene, gaseous ²⁾	TR	◐	○	○
Butanols (butyl alcohols)	TR	●	◐	◐
Butane-1,2,4-triol ²⁾	TR	●	●	–
But-2-ene-1,4-diol ²⁾	TR	●	●	–
But-2-ene-1,4-diol ²⁾	TR	●	–	–
Butyric acids, aqueous	20%	●	–	–
Butyl acetates(acetic acid butyl esters)	TR	◐	○	○
Butylenes, liquid ²⁾ (butenes)	TR	◐	–	–
Butylene glycols (butanediols) aqueous ²⁾	10%(Vol.)	●	◐	–
Butylene glycols (butanediols) ²⁾	TR	●	●	–
Butylglycol (ethylene glycol monobutyl ether)	TR	●	–	–
Butylphenols	GL	●	–	–

Flow Substance	Content ¹⁾ %	Behavior at		
		20°C / 68 °F	60°C / 140 °F	100°C / 212 °F
Butylphenone ²⁾	TR	○	–	–
Butyl phthalate (dibutyl phthalate)	TR	●	◐	◐
Calcium carbonate	GL	●	●	●
Calcium chloride	GL	●	●	●
Calcium hydroxide	GL	●	●	–
Calcium hypochlorite	L	●	–	–
Calcium nitrate	GL	●	●	–
Camphor oil	TR	○	○	○
Carbolineum ²⁾	H	●	–	–
Chlorine, gaseous, dry	TR	○	○	○
Chlorine, gaseous, moist ²⁾	0.50%	◐	–	–
Chlorine, gaseous, moist ²⁾	1%	○	○	○
Chlorine, liquid	TR	○	○	○
Chlorine (chlorine water)	GL	◐ ⁴⁾	○	○
Chloral ²⁾ (trichloroacetaldehyde)	TR	●	●	–
Chloral hydrate ²⁾	TR	◐	○	○
Chloramine ²⁾	L	●	–	–
Chlorobenzene ²⁾	TR	◐	–	–
Chloroacetic acid, mono, aqueous	L	●	● ²⁾	–
Chloroacetic, mono, aqueous	85% ²⁾	●	●	–
Chloroethane (ethyl chloride)	TR	○	○	○
2-Chloroethanol (ethylene chlorohydrin)	TR	●	● ²⁾	–
Bleaching powder suspension in water ²⁾	any	●	●	–
Chloroform (trichloromethane)	TR	◐	○	○
Chloric acid, aqueous ²⁾	1%	●	◐	○
Chloric acid, aqueous ²⁾	10%	●	◐	○
Chloric acid, aqueous	20%	●	○	○
Chlorosulphonic acid (chlorosulphuric acid)	TR	○	○	○
Chlorine water (chlorine)	GL	◐ ⁴⁾	○	○
Hydrogen chloride, dry gas	TR	●	●	–
Hydrogen chloride, moist gas ²⁾ (hydrochloric acid)	TR	●	●	–
Chrome alum (alums)	GL	●	●	–
Chromic acid, aqueous	40%	◐ ⁴⁾	◐	○
Chromic acid/sulphuric acid/water ²⁾ (chromic/sulphuric acid)	15/35/50%	○	○	○
Citric acid	VL	●	●	●
Crotonaldehyde ²⁾ (2-butenal)	TR	●	–	–
Potassium cyanide	L	●	● ²⁾	–
Cyclohexane	TR	●	–	–
Cyclohexanol	TR	●	◐	–
Cyclohexanone	TR	◐	○	○
Dekalin (decahydronaphthalene)	TR	◐ ³⁾	○	○
Dextrin (starch gum)	L	●	●	–
Dextrose (glucose)	20%	●	●	●
1,2-Diaminoethane (ethylenediamine) ²⁾	TR	●	●	–

Flow Substance	Content ¹⁾ %	Behavior at		
		20°C / 68 °F	60°C / 140 °F	100°C / 212 °F
Di-n-butyl ether ²⁾	TR	◐	○	○
Dibutyl phthalate (phehalic acid dibutyl ester)	TR	●	◐	○
Dichloroethylene (1,1- and 1, 2-)	TR	◐	–	–
Dichlorobenzenes ²⁾	TR	◐	–	–
Dichloroacetic acid	TR	◐	–	–
Dichloroacetic acid, aqueous ²⁾	50%	●	●	–
Dichloroacetic acid methyl ester ²⁾	TR	●	●	–
Diesel fuel ²⁾	H	●	◐	–
Diethanolamine	TR	●	–	–
Diethyl ether (ether)	TR	●	◐	–
Diglycollic acid	GL	●	● ²⁾	–
Dihexyl phthalate ²⁾	TR	●	◐	–
Diisobutyl ketone ²⁾ (2,6-dimethylheptan-4-one)	TR	●	○	○
Diisopropyl ether	TR	◐	○ ²⁾	–
Diisooctyl phthalate	TR	●	◐	–
Dimethylamine, gaseous	100%	●	–	–
N, N-Dimethylformamide	TR	●	●	–
Dinonyl phthalate ²⁾ (DNP)	TR	●	◐	–
Dioctyl phthalate (DOP)	TR	● ³⁾	◐	–
1,4-dioxane (diethylene dioxide)	TR	◐	◐	–
Fertilizer salts ²⁾	GL	●	●	–
Iron (II) and (III) chloride ²⁾	GL	●	●	–
Natural gas	TR	●	–	–
Peanut oil	TR	●	●	–
Vinegar (wine vinegar)	H	●	●	●
Acetic acid, aqueous (glacial acetic acid)	TR	●	◐	○
Acetic acid, aqueous and vinegar essence	50%	●	●	◐
Acetic acid, aqueous	up to 40%	●	●	–
Acetic acid anhydride	TR	●	–	–
Acetic acid ethyl ester (ethyl acetate)	TR	● ³⁾	◐ ³⁾	○
Acetic acid methyl ester (methyl acetate)	TR	●	●	–
Ethanol (ethyl alcohol)	TR	●	●	●
Ethanol, denatured with 2% of toluene ²⁾	96%(Vol.)	●	–	–
Ethylbenzene ²⁾	TR	◐	○	○
Ethyl chloride, gaseous (chloroethane)	TR	○	○	○
Ethylene chlorohydrin (chloroethanol)	TR	●	● ²⁾	–
Ethylenediamine (1,2-diaminoethane)	TR	●	●	–
Ethylene glycol	TR	●	●	●
Ethylene oxide, liquid ²⁾ (oxirane)	TR	○	–	–
Fatty acids (from C ₄) ²⁾	TR	●	◐	–
Pine-needle oil ²⁾	H	●	◐	–
Fluorine, dry ²⁾	TR	◐	–	–
Fluorosilicic acid ²⁾ , aqueous	32%	●	●	–
Hydrofluoric acid, aqueous ²⁾	40%	●	●	–

Flow Substance	Content ¹⁾ %	Behavior at		
		20°C / 68 °F	60°C / 140 °F	100°C / 212 °F
Hydrofluoric acid, aqueous ²⁾	70%	●	◐	–
Formaldehyde, aqueous	40%	●	● ²⁾	–
Photo emulsions ²⁾	H	●	●	–
Photo developer baths ²⁾	H	●	●	–
Photo fixing baths ²⁾	H	●	●	–
Antifreeze (automobiles) ²⁾	H	●	●	●
Fruit drinks and fruit juices	H	●	●	●
Fructose (fruit sugar)	L	●	●	●
Furfuryl alcohol ²⁾	TR	●	◐	–
Fermentation mash ²⁾	H	●	●	–
Gelatine	L	●	●	● ²⁾
Tannin extract, vegetable ²⁾	H	●	○	–
Tannic acid (tannin), aqueous ²⁾	10%	●	○	–
Glucose, aqueous	20%	●	●	●
Glycerol	TR	●	●	●
Glycollic acid, aqueous	30%	●	◐ ²⁾	–
Urea	GL	●	● ²⁾	–
Yeast ²⁾	any	●	–	–
Heating Oil ²⁾	H	●	◐	–
Heptanes	TR	● ³⁾	◐ ³⁾	○
Hexanes	TR	●	◐	–
Hexane-1,2,6-triol ²⁾	TR	●	●	–
Hydrazine hydrate ²⁾	TR	●	–	–
Hydroquinone ²⁾	L	●	–	–
Hydroxylammonium sulphate ²⁾	12%	●	●	–
Isooctane	TR	● ³⁾	◐ ³⁾	○
Isopropanol (propan-2-01)	TR	●	●	●
Tincture of iodine	H	●	◐ ²⁾	–
Potassium hydroxide solution, aqueous	50%	●	●	●
Potassium bromate, aqueous	10%	●	●	–
Potassium bromide	GL	●	●	–
Potassium carbonate (potash)	GL	●	● ²⁾	–
Potassium chlorate	GL	●	●	–
Potassium chloride	GL	●	● ²⁾	–
Potassium chromate	GL	●	●	–
Potassium cyanide	L	●	● ²⁾	–
Potassium dichromate ²⁾	GL	●	●	–
Potassium fluoride	GL	●	●	–
Potassium hexacyanoferrate-(II) and -(III) ²⁾ (yellow and red potassium ferro- and ferricyanide)	GL	●	●	–
Potassium bicarbonate	GL	●	●	–
Potassium iodide	GL	●	● ²⁾	–
Potassium nitrate	GL	●	●	–

Flow Substance	Content ¹⁾ %	Behavior at		
		20°C / 68 °F	60°C / 140 °F	100°C / 212 °F
Potassium perchlorate, aqueous	10%	●	●	–
Potassium permanganate	GL	●	○ ²⁾	–
Potassium peroxodisulphate (potassium persulphate)	GL	●	● ²⁾	–
Potassium sulphate	GL	●	● ²⁾	–
Fluoro silicic acid	32%	●	●	–
Silicic acid, aqueous ²⁾	any	●	●	–
Common salt (sodium chloride)	VL	●	●	●
Aqua regia (HCl/HNO ₃)	75%/25%	○	○	○
Carbon dioxide, gaseous	any	●	●	–
Carbon dioxide (carbonic acid), aqueous ²⁾	any	●	●	–
Coconut fat alcohol ²⁾	TR	●	◐	–
Coconut oil (coconut fat, copra)	TR	●	–	–
Cresols	90%2	●	●	–
Cresols	>90%	●	–	–
Copper(II) chloride	GL	●	●	–
Copper(I) cyanide ²⁾	GL	●	●	–
Copper(II) nitrate, aqueous	30%	●	●	●
Copper(II) sulphate	GL	●	●	–
Lanolin (wool fat)	H	●	◐	–
Linseed oil	H	●	●	●
Illuminating gas ²⁾	H	●	–	–
Air	TR	●	●	●
Magnesium chloride	GL	●	●	● ²⁾
Magnesium hydroxide carbonate	GL	●	●	●
Magnesium salts ²⁾	GL	●	●	–
Magnesium sulphate	GL	●	●	● ²⁾
Maize germ oil	TR	●	◐	–
Machine oil ²⁾	TR	●	◐	○
Sea-water	H	●	●	●
Molasses ²⁾	H	●	●	●
Menthol ²⁾	TR	●	◐	–
Methanol (methyl alcohol)	TR	●	●	–
Methanol (methyl alcohol)	5%	●	● ³⁾	◐
Methanesulphonic acid, aqueous ²⁾ (methylsulphuric acid)	50%	◐	◐	○
Methanesulphonic acid, aqueous ²⁾ (methylsulphuric acid)	50 bis 100%	◐	○	○
Methoxybutanol ²⁾	TR	●	◐	–
Methyl acetate see (acetic acid methyl ester)	TR	●	●	–
Methylamine, aqueous	32%	●	–	–
Methyl bromide (bromomethyl)	TR	○	○	○
Methyl chloride, gaseous ²⁾ (chloromethyl)	TR	○	○	○
Methylene chloride (dichloromethane)	TR	◐	○	○
Methyl ethyl ketone ²⁾	TR	●	◐	–
Milk	H	●	●	●
Lactic acid	90%	●	●	–

Flow Substance	Content ¹⁾ %	Behavior at		
		20°C / 68 °F	60°C / 140 °F	100°C / 212 °F
Mineral water	H	●	●	●
Engine lubrication oils ²⁾	TR	●	◐	–
Naphtha	H	●	○	○
Sodium acetate	GL	●	●	●
Sodium benzoate, aqueous	35%	●	● ²⁾	–
Sodium borate-hydrogen peroxide (sodium perbarate)	GL	●	–	–
sodium carbonate, aqueous	50%	●	●	◐
Sodium chlorate	GL	●	● ²⁾	–
Sodium chloride	VL	●	●	●
Sodium chlorite, aqueous	2 to 20%	●	◐	○
Sodium dichromate	GL	●	●	●
Sodium hexametaphosphate	L	●	● ²⁾	–
Sodium bicarbonate	GL	●	●	●
Sodium bisulphate	GL	●	●	–
Sodium bisulphite	L	●	–	–
Sodium hypochlorite, aqueous	10%	●	–	–
Sodium hypochlorite, aqueous	20%	◐ ⁴⁾	◐	○ ²⁾
Sodium nitrate	GL	●	●	–
Sodium nitrite ²⁾	G	●	●	–
Sodium phosphate, tri	GL	●	●	●
Sodium silicate, (water-glass)	L	●	●	–
Sodium sulphate	GL	●	●	–
Sodium sulphide	GL	●	● ²⁾	–
Sodium sulphite, aqueous	40%	●	●	●
Sodium tetraborate	L	●	●	–
Sodium thiosulphate	GL	●	● ²⁾	–
Sodium hydroxide solution, aqueous	up to 60%	●	●	●
Nickel salts ²⁾	GL	●	●	–
Nitrobenzene	TR	●	◐	–
2-Nitrotoluene ²⁾	TR	●	◐	○
Fruit pulps ²⁾	H	●	–	–
Octylcresol ²⁾	TR	◐	○	○
Oils and fats (animal and vegetable)	TR	●	◐	–
Oleic acid	TR	●	◐	–
Oleum (H ₂ SO ₄ + SO ₃)	TR	○	○	○
Olive oil	TR	●	●	◐
Oxalic acid	GL	●	● ³⁾	○
Ozone ²⁾	0.5ppm	●	◐	–
Paraffin emulsions ²⁾	H	●	●	–
Paraffin oil	TR	●	◐	○
Perchloroethylene (tetrachloroethylene) ²⁾	TR	◐	◐	–
Perchloric acid, aqueous	20%	●	● ²⁾	–
Petroleum ether	TR	● ³⁾	◐	–

Flow Substance	Content ¹⁾ %	Behavior at		
		20°C / 68 °F	60°C / 140 °F	100°C / 212 °F
Petroleum	TR	●	◐	–
Peppermint oil	TR	●	–	–
Phenol, aqueous	5%	●	●	–
Phenol, aqueous	90%	●	–	–
Phenylhydrazine ²⁾	TR	◐	◐	–
Phenylhydrazinium chloride ²⁾	TR	●	◐	–
Phosgene, gaseous ²⁾ (carbonyl chloride)	TR	◐	◐	–
Phosphates ²⁾ (inorganic)	GL	●	●	–
Phosphorus(III) chloride ²⁾	TR	◐	–	–
Phosphorus oxychloride	TR	◐	–	–
Phosphoric acid, ortho	85%	●	●	●
Phthalic acid ²⁾	GL	●	●	–
Picric acid (2, 4, 6 - trinitrophenol)	GL	●	–	–
Propane, gaseous	TR	●	–	–
Propan-1-ol ²⁾ (propyl alcohol)	TR	●	●	–
Propargyl alcohol, aqueous ²⁾	7%	●	●	–
Propionic acid, aqueous	>50%	●	● ²⁾	–
Propylene glycols ²⁾	TR	●	●	–
Pyridine	TR	◐	◐ ²⁾	–
Mercury	TR	●	●	–
Mercury salts ²⁾	GL	●	●	–
Castor oil	TR	●	●	–
Aqueous ammonia (ammonia water)	GL	●	● ²⁾	–
Nitric acid, aqueous	10%	●	◐ ³⁾	○
Nitric acid, aqueous	10-50%	◐	○ ²⁾	○ ²⁾
Nitric acid, aqueous	>50%	○	○	○
Hydrochloric acid, aqueous	up to 20%	●	●	–
Hydrochloric acid, aqueous	>20 to 36%	●	◐ ²⁾	◐ ²⁾
Oxygen	TR	●	–	–
Lubricating oils ²⁾	H	◐	–	–
Sulphur dioxide, gaseous	TR	●	● ²⁾	–
Sulphur dioxide, gaseous (sulphurous acid)	any	●	● ²⁾	–
Carbon disulphide	TR	○	○	○
Sulphuric acid, aqueous	10%	●	●	●
Sulphuric acid, aqueous	>10 to 80%	●	●	–
Sulphuric acid, aqueous	>80 to TR	◐	○	–
Sulphuric acid, fuming (oleum)		○	○	○
Hydrogen sulphide, gaseous	TR	●	●	–
Sea-water	H	●	●	●
Silver nitrate	GL	●	●	◐
Silver salts ²⁾	GL	●	●	–
Silicone oil	TR	●	●	●
Silicone emulsion ²⁾	H	●	●	–

Flow Substance	Content ¹⁾ %	Behavior at		
		20°C / 68 °F	60°C / 140 °F	100°C / 212 °F
Soda (sodium carbonate)	50%	●	●	◐
Soybean oil	TR	●	◐	–
Spindle oil ²⁾	TR	●	◐	○
Starch	any	●	●	–
Starch gum (dextrin)	L	●	●	–
Starch syrup ²⁾	any	●	●	–
Sulphuryl chloride ²⁾	TR	○	○	○
Terpentine oil	TR	○	○	○
White spirit ²⁾	TR	●	◐	○
Tetrachloroethane ²⁾	TR	◐	○	○
Tetrachloroethylene (perchloroethylene)	TR	◐	◐	–
Carbon tetrachloride (tetrachloromethane)	TR	○	○	○
Tetrahydrofuran	TR	◐	○	○
Tetrahydronaphthalene (tetralin)	TR	○	○	○
Thionyl chloride ²⁾	TR	◐	○	○
Thiophene	TR	●	◐	–
Toluene	TR	◐	○	○
Transformer oil (insulating oil) ²⁾	TR	◐	○	–
Grape sugar (glucose)	20%	●	●	●
Triethanolamine	L	●	–	–
Trichloroethylene	TR	○	○	○
Trichloroacetic acid, aqueous	50%	●	●	–
Tricresyl phosphate ²⁾ (phosphoric acid tritoyl ester)	TR	●	◐	–
Drinking water, chlorinated ²⁾	TR	●	●	●
Triocyl phosphate ²⁾	TR	●	–	–
Vaseline oil ²⁾	TR	●	◐	–
Vinyl acetate ²⁾	TR	●	◐	–
Vinylidene chloride (1,1-dichloroethylene)	TR	◐	–	–
Detergents ²⁾	VL	●	●	–
Water, pure	H	●	●	●
Hydrogen	TR	●	● ²⁾	–
Hydrogen peroxide, aqueous	30%	●	◐	–
Wines	H	●	● ²⁾	–
Wine vinegar, table vinegar	H	●	●	●
Tartaric acid, aqueous	10%	●	●	–
Xdylene (all isomers)	TR	◐ ³⁾	○	○
Zinc salts ²⁾	GL	●	●	–
Tin(II) chloride	GL	●	●	–
Tin(IV) chloride	GL	●	●	–
Citric acid	VL	●	●	●
Sugar syrup ²⁾	H	●	●	–

Barleans Organic Oils, USA

REFERENCES



Blythewood, USA

CSU Data, USA



REFERENCES

Daikin AC, USA



Epic Brewery, USA



Hancock Medical, USA



REFERENCES

Lifeline Data, USA



LLNL, USA



Neenah Paper, USA

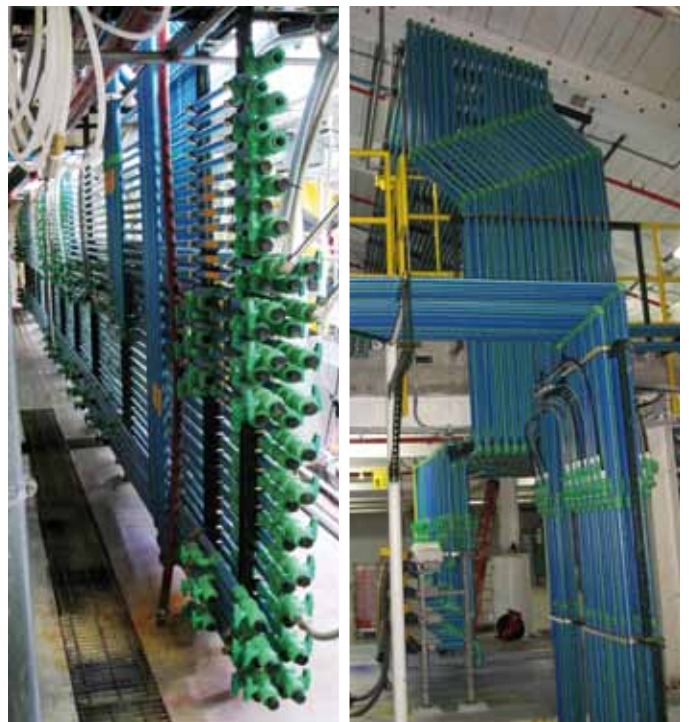
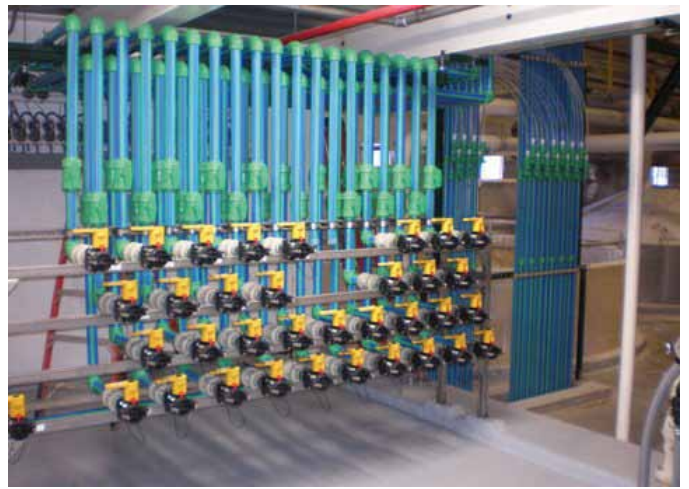

REFERENCES

Park Orchard Elementary School, USA



IP Casino, USA

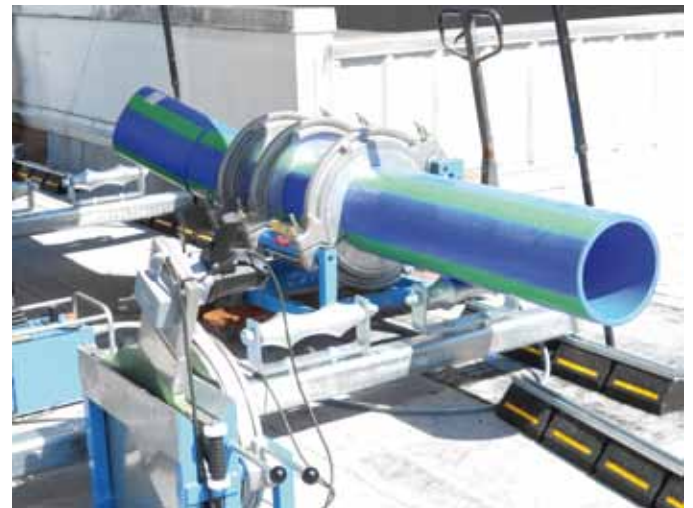

Starbucks, USA



REFERENZEN

Flex Tower, RAK, UAE



Millerntor stadium, FC St. Pauli 1910 e.V.

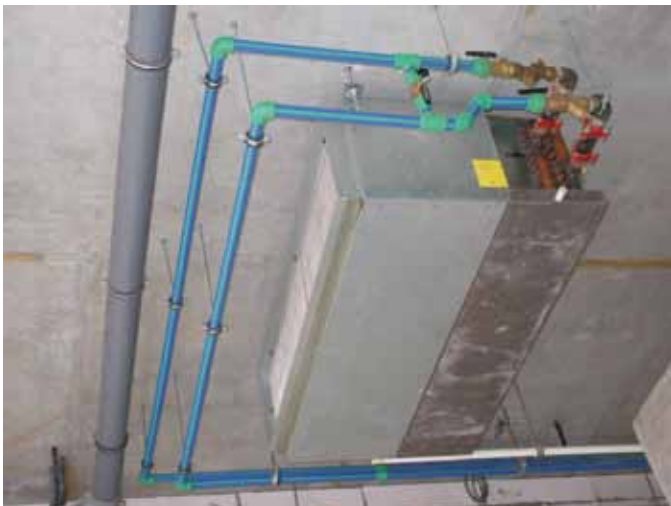

Hellenic Telecoms AG, Athens, Greece



Ecolab, Monheim



Hotel Kalimera, Kreta, Greece



Al Sayegh Tower, Sharjah, UAE



TRANSPORT UND LAGERUNG

aquatherm PP-R -pipes may be stored outside at any temperature. A solid base for the pipe is very important to avoid a deformation of the pipes while in transport and storage.

At temperatures below 0 °C it is possible to damage the pipes through strong impacts. The material has to be treated with caution at low temperatures.

In spite of its high resistance aquatherm -pipes should be treated with care.

UV-radiation has effects on all high polymer plastics. Do not store permanently outdoor. Maximum storage time (outdoor) is 6 months.



TABLE OF CONTENTS

- **aquatherm blue pipe**-pipes
- Fastening material
- Fittings
- Weld-in saddle
- Threaded connections and accessories
- Transition pieces
- Screwed connections and counter parts
- Distributors
- Valves and accessories
- Cutting tools, welding devices
- Welding machines and welding jig
- Butt welding machines & electrofusion device
- Peeling tools
- Saddle welding tools
- Drills & saddle peeling tool

climatherm our specialty for distributing cooling and heating in closed systems as well as in several industrial applications, will become **aquatherm blue pipe**. This system was developed 10 years ago in order to prevent corrosion in air conditioning pipes and quickly expanded its range of application, with many positive features for other fields of piping installation. It has gone on to find success around the world in hotels, stadiums, schools, offices, and industrial applications.

aquatherm blue pipe

Pipe system made of polypropylene

for chilled, hot fluid and various industrial applications

article-no.	old brand name	new branding structure					
		new brand name		Standard Dimension Ratio	structure of pipe	special feature of pipe	material
		company	system				
2010208 . . . 2010212	climatherm SDR11	aquatherm	blue pipe	SDR 11	S		PP-R
2070112 . . . 2070712	climatherm faser composite pipe SDR7,4/SDR11	aquatherm	blue pipe	SDR 7,4/SDR 11	MF		PP-R
2070162 . . . 2070762	climatherm faser composite pipe SDR7,4/SDR11/SDR17,6 UV	aquatherm	blue pipe	SDR 7,4/SDR 11/ SDR 17,6	MF	UV	PP-R
2170114 . . . 2170712	climatherm faser composite pipe SDR7,4/SDR11 OT	aquatherm	blue pipe	SDR 7,4/SDR 11	MF	OT	PP-R
2570130 . . . 2570154	climatherm faser composite pipe SDR17,6	aquatherm	blue pipe	SDR 17,6	MF		PP-R
2270111 . . . 2270142	climatherm faser composite pipe SDR7,4/SDR11 ISO	aquatherm	blue pipe	SDR 7,4/SDR 11	MF	TI	PP-R
2470711 . . . 2470126	climatherm faser composite pipe SDR7,4/SDR11 OT ISO	aquatherm	blue pipe	SDR 7,4/SDR 11	MF	OT-TI	PP-R

aquatherm blue pipe - SDR 7,4 / 11 / 17,6 MF

Structure of pipe: MF = multilayer, with fibre reinforced
 Material: fusiolen PP-R
 Pipe series: SDR 7,4/S 3,2 & SDR 11 / S 5 & SDR 17,6 / S 8,3
 Standards: SKZ HR 3.28, ASTM F 2389, CSA B 137.11, ISO 21003
 Colour: blue with 4 wider green stripes
 Form supplied: ø 20-125mm straight lengths 4 m
 ø 160-630mm straight lengths 5,8 m
 Packing Unit: PU in meter

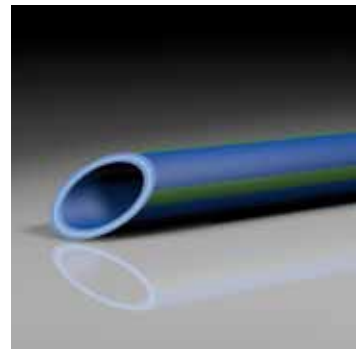
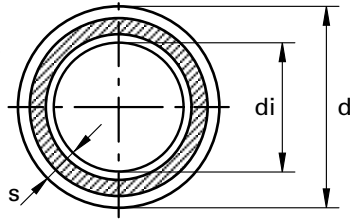

Application:



Mechanically stabilized through a fibre mix integrated in the middle layer of the fusiolen® PP-R.

SDR	Art.-No.	Dimension d [mm]	Wall thickness s [mm]	Internal diameter di [mm]	Water content [l/m]	Weight [kg]	DN	PU [m]	Price € m/pc	
7,4	Socket welding									
	2070708	20	2,8	14,4	0,163	0,159	15	100		
	2070710	25	3,5	18,0	0,254	0,244	20	100		
	2070712	32	4,4	23,2	0,423	0,275	25	40		
11	2070112	32	2,9	26,2	0,539	0,285	25	40		
	2070114	40	3,7	32,6	0,834	0,435	32	40		
	2070116	50	4,6	40,8	1,307	0,675	40	20		
	2070118	63	5,8	51,4	2,074	1,065	50	20		
	2070120	75	6,8	61,4	2,959	1,482	65	20		
	2070122	90	8,2	73,6	4,252	2,145	80	12		
	2070124	110	10,0	90,0	6,359	3,175	-	8		
	2070126	125	11,4	102,2	8,199	4,118	100	4		
		Butt welding								
		2070130	160	14,6	130,8	13,430	6,728	125	5,8	
	2070134	200	18,2	163,6	21,010	10,480	150	5,8		
	2070138	250	22,7	204,6	32,861	16,300	200	5,8		
	2070142	315	28,6	257,8	52,172	25,700	250	5,8		
	2070144	355	32,2	290,6	66,29	33,034	300	5,8		
	2070146	400	36,3	327,6	84,290	41,400	300	5,8		
	2070148	450	40,9	368,2	106,477	52,400	400	5,8		
17,6	Socket welding									
	NEW 2570126	125	7,1	110,8	9,637	2,698	100	4		
	Butt welding									
	2570130	160	9,1	141,8	15,792	4,360	150	5,8		
	2570134	200	11,4	177,2	24,661	6,800	200	5,8		
	2570138	250	14,2	221,6	38,568	10,570	250	5,8		
	2570142	315	17,9	279,2	61,223	16,740	300	5,8		
	2570144	355	20,1	314,8	77,832	21,210	350	5,8		
	2570146	400	22,7	354,6	98,756	26,930	350	5,8		
	2570148	450	25,5	399,0	125,036	34,020	400	5,8		
	2570150	500	28,4	443,2	154,272	42,070	450	5,8		
2570152	560	31,7	496,6	193,688	52,550	500	5,8			
2570154	630	35,7	558,6	245,070	66,540	500	5,8			

aquatherm blue pipe - SDR 7,4/11/17,6 MF UV

Structure of pipe: MF = multilayer, with fibre reinforced
 Special feature of pipe: UV resistant
 Material: fusiolen PP-R
 Pipe series: SDR 7,4/S 3,2 & SDR11/SDR 17,6 / S 8,3
 Standards: SKZ HR 3.28, ASTM F 2389, CSA B 137.11, ISO 21003
 Colour: outside: black, inside: blue
 Form supplied: ø 20-125mm straight lengths 4 m
 ø 160-250mm straight lengths 5,8 m
 Packing Unit: PU in meter
 Application:

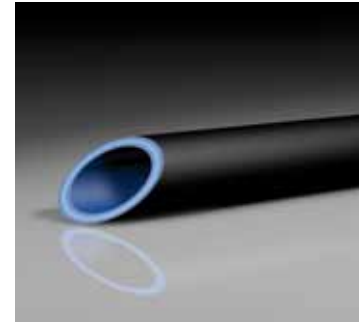
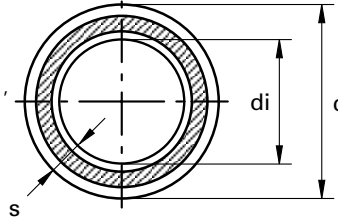

UV-resistant. Mechanically stabilized by a fibre mixture, integrated in the middle layer of fusiolen PP-R.

SDR	Art.-No.	Dimension d [mm]	Wall thickness s [mm]	Internal diameter di [mm]	Water content [l/m]	Weight [kg]	DN	PU [m]	Price € m/pc	
7,4	Socket welding									
	2070758	20	2,8	14,4	0,163	0,209	15	100		
	2070760	25	3,5	18,0	0,254	0,313	20	100		
	2070762	32	4,4	23,2	0,423	0,345	20	40		
11	2070162	32	2,9	26,2	0,539	0,375	25	40		
	2070164	40	3,7	32,6	0,834	0,554	32	40		
	2070166	50	4,6	40,8	1,307	0,825	40	20		
	2070168	63	5,8	51,4	2,074	1,257	50	20		
	2070170	75	6,8	61,4	2,959	1,707	65	20		
	2070172	90	8,2	73,6	4,252	2,483	80	12		
	2070174	110	10,0	90,0	6,359	3,688		8		
	2070176	125	11,4	102,2	8,199	4,673	100	4		
		Butt welding								
		2070180	160	14,6	130,8	13,430	7,512	125	5,8	
	2070184	200	18,2	163,6	21,010	11,411	150	5,8		
	2070188	250	22,7	204,6	32,861	17,754	200	5,8		
	2070192	315	28,6	257,8	52,172	26,619	250	5,8		
	2070194	355	32,2	290,6	66,292	33,668	300	5,8		
	2070196	400	36,3	327,4	84,145	42,566	300	5,8		
	2070198	450	40,9	368,2	106,423	53,709	400	5,8		
17,6	2570180	160	9,1	141,8	15,784	4,839	150	5,8		
	2570184	200	11,4	177,2	24,649	7,396	200	5,8		
	2570188	250	14,2	221,6	38,549	11,321	250	5,8		
	2570192	315	17,9	279,2	61,193	17,676	300	5,8		
	2570194	355	20,1	314,8	77,793	22,266	350	5,8		
	2570196	400	22,7	354,6	98,707	28,124	350	5,8		
	2570198	450	25,5	399	124,973	35,364	400	5,8		
	2570200	500	28,4	443,2	154,195	43,563	450	5,8		
	2570202	560	31,7	496,6	193,590	54,224	500	5,8		
	2570204	630	35,7	558,6	244,947	68,420	500	5,8		

aquatherm blue pipe - SDR 7,4 / 11 MF OT

Structure of pipe: MF = multilayer, with fibre reinforced
 Special feature of pipe: OT = oxygen tight
 Material: fusiolen PP-R
 Pipe series: SDR 7,4/S 3,2 & SDR11 / S 5
 Standards: DIN 8077/78, DIN EN ISO 15874, ASTM F 2389, CSA B 137.11, ISO 21003
 Colour: blue
 Form supplied: \varnothing 20-125mm straight lengths 4 m
 \varnothing 160-250mm straight lengths 5,8 m
 Packing Unit: PU in meter
 Application:

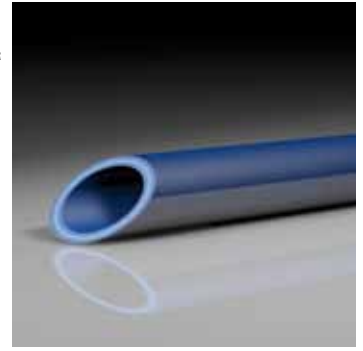
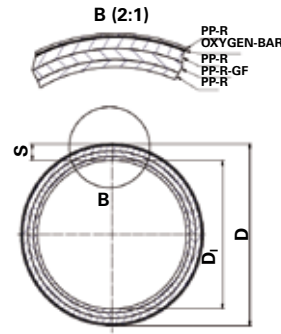

Oxygen tight by diffusion barrier.
 Mechanically stabilized through a fibre mix integrated in the middle layer of fusiolen® PP-R.

SDR	Art.-No.	Dimension d [mm]	Wall thickness s [mm]	Internal diameter di [mm]	Water content [l/m]	Weight [kg]	DN	PU [m]	Price € m/pc
7,4	Socket welding								
	2170708	20	2,8	14,4	0,163	0,199	15	100	
	2170710	25	3,5	18,0	0,254	0,299	20	100	
11	2170712	32	4,4	23,2	0,423	0,466	20	40	
	2170114	40	3,7	32,6	0,834	0,530	32	40	
	2170116	50	4,6	40,8	1,307	0,794	40	20	
	2170118	63	5,8	51,4	2,074	1,218	50	20	
	2170120	75	6,8	61,4	2,959	1,649	65	20	
	2170122	90	8,2	73,6	4,252	2,379	80	12	
	2170124	110	10	90,0	6,359	3,550		8	
	2170126	125	11,4	102,2	8,199	4,576	100	4	
	Butt welding								
		2170130	160	14,6	130,8	13,430	7,284	125	5,8
	2170134	200	18,2	163,6	21,010	11,000	150	5,8	
	2170138	250	22,7	204,6	32,861	16,700	200	5,8	

aquatherm blue pipe - SDR 11 S

Structure of pipe: S (single)
 Material: fusiolen PP-R
 Pipe series: SDR 11/S 5
 Standards: DIN 8077/78, DIN EN ISO 15874, ASTM F 2389, CSA B 137.11, NSF 14, ISO 21003
 Colour: blue
 Form supplied: 4 m straight lengths, also* in coils
 Packing Unit: PU in meter
 Application:

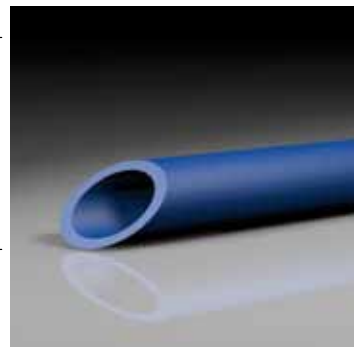
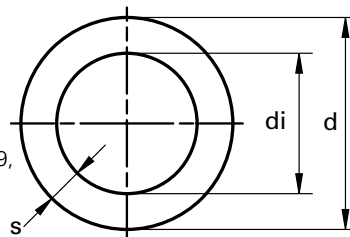

SDR	Art.-No.	Dimension d [mm]	Wall thickness s [mm]	Internal diameter di [mm]	Water content [l/m]	Weight [kg]	DN	PU [m]	Price € m/pc
11	2010208	20	1,9	16,2	0,206	0,110	15	100	
	2010210	25	2,3	20,4	0,327	0,167	20	100	
	2010212	32	2,9	26,2	0,539	0,265	25	40	
	2010308*	20	1,9	16,2	0,206	0,107	15	100	
	2010310*	25	2,3	20,4	0,327	0,164	20	100	
	2010312*	32	2,9	26,2	0,539	0,257	25	40	

ADHESIVE TAPE TO PROTECT AGAINST UV-RADIATION

for aquatherm-pipes MF UV

Art.-No.	Dimension	PU	Price € m/pc
10870	Width: 30mm Length: 10m	10m/pckg	
10871	Width: 50mm Length: 10m	10m/pckg	

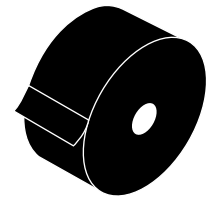

PIPE CLAMPS

Suitable for sliding and fixed point installation.

Thread connection: M8 & M10 for 16 - 125 mm | M10 for 160 mm | M16 for 200 - 355 mm

Art.-No.	for pipe dimension	PU	Box unit	Price € m/pc
60520	20 mm	50		
60525	25 mm	50		
60532	32 mm	50		
60540	40 mm	50		
60550	50 mm	50		
60563	63 mm	25		
60575	75 mm	25		
60590	90 mm	25		
60594	110 mm	25		
60595	125 mm	25		
60597	160 mm	25		
60650	200 mm	1		
60654	250 mm	1		
60658	315 mm	1		
60660	355 mm	1		

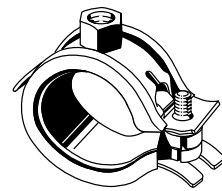

PIPE CLAMPS

suitable for fixed point installation

Art.-No.	for pipe dimension	PU	Box unit	Price € m/pc
60768	160 mm	1	1	
60770	200 mm	1	1	
60774	250 mm	1	1	
60778	315 mm	1	1	
60780	355 mm	1	1	
60782	400 mm	1	1	
60784	450 mm	1	1	
60786	500 mm	1	1	
60788	560 mm	1	1	
60790	630 mm	1	1	

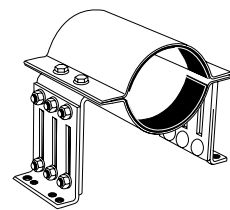

PIPE FASTENING BOW

suitable for ø 16 - 32 mm pipes

Art.-No.	for pipe dimension	PU	Box unit	Price € m/pc
60604	onefold - length = 45 mm	50		
60606	onefold - length = 75 mm	50		
60608	double - length = 45 mm	50		
60610	double - length = 75 mm	50		

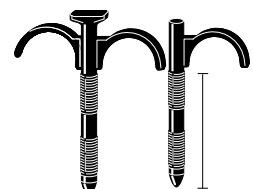

PLASTIC PIPE CLAMPS

suitable for \varnothing 20 - 40 mm pipes

Art.-No.	for pipe dimension	PU	Box unit	Price € m/pc
60620	20 mm	50		
60625	25 mm	30		
60632	32 mm	30		
60640	40 mm	30		

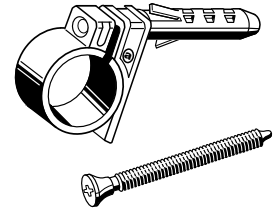

PIPE SUPPORT

Art.-No.	for pipe dimension	PU	Box unit	Price € m/pc
85110	\varnothing 16 x 2,2 mm - \varnothing 11,4 mm	10		
10186	\varnothing 16 x 2,7 mm - \varnothing 10,4 mm	10		

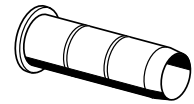

SOCKET

Material: Fusiolen® PP-R
 Standard: DIN 16962, DIN EN ISO 15874
 Colour: green

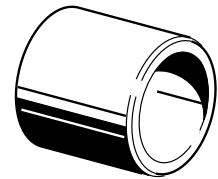
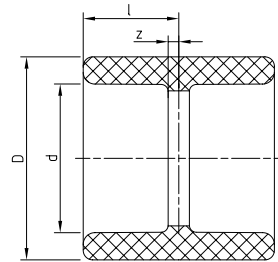

SDR	Art.-No.	Dimension d [mm]	l	z	D	Weight [kg]	PU	Box unit	Price € m/pc
	11008	20	16,00	1,50	29,50	0,011	10	1500	
	11010	25	17,50	1,50	34,00	0,014	10	1000	
	11012	32	20,25	2,25	43,00	0,026	5	600	
	11014	40	23,75	3,25	52,00	0,044	5	400	
	11016	50	26,50	3,00	68,00	0,084	5	200	
	11018	63	30,25	2,75	84,00	0,139	1	100	
	11020	75	33,25	3,25	100,00	0,226	1	80	
	11022	90	36,25	3,25	120,00	0,343	1	50	
	11024	110	41,00	4,00	147,00	0,583	1	30	
	11026	125	45,00	5,00	167,00	0,844	1	25	

REDUCING SOCKET FEMALE/FEMALE

Material: Fusiolen® PP-R
 Standard: DIN 16962, DIN EN ISO 15874
 Colour: green

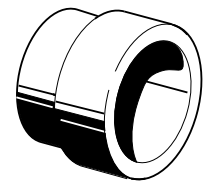
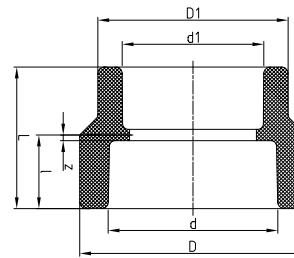

SDR	Art.-No.	Dimension d [mm]	Dimension d1 [mm]	L	l	z	D	D1	Weight [kg]	PU	Box unit	Price € m/pc
7,4 11 17,6	double-sided socket welding											
	11222	40	32,00	44,00	24,00	3,50	52,00	43,00	0,050	1	40	
	11228	50	32,00	47,00	26,50	3,00	68,00	43,00	0,093	1	25	
	11230	50	40,00	50,50	26,50	3,00	68,00	52,00	0,098	1	100	
	11236	63	40,00	54,00	30,50	3,00	84,00	52,00	0,163	1	100	
	11238	63	50,00	56,00	30,00	2,50	84,00	68,00	0,171	1	100	
	11240	75	50,00	60,00	33,50	3,50	100,00	68,00	0,258	1	80	
	11242	75	63,00	62,50	32,50	2,50	100,00	84,00	0,268	1	80	
	11252	90	63,00	66,50	36,50	3,50	120,00	84,00	0,414	1	30	
	11253	90	75,00	69,00	36,00	3,00	120,00	100,00	0,430	1	50	
	11257	110	75,00	74,50	41,00	4,00	147,00	100,00	0,733	1	45	
	11259	110	90,00	77,50	41,00	4,00	147,00	120,00	0,729	1	35	
	11263	125	90,00	83,00	46,00	6,00	167,00	120,00	1,075	1	25	
	11265	125	110,00	87,00	46,00	6,00	167,00	147,00	1,090	1	20	

REDUCING SOCKET, SOCKET WELDING

Material: Fusiolen® PP-R
 Standard: DIN 16962, DIN EN ISO 15874
 Colour: green

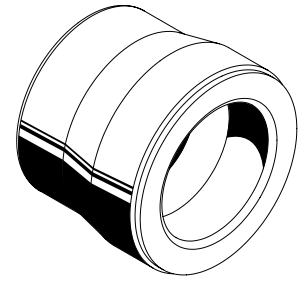
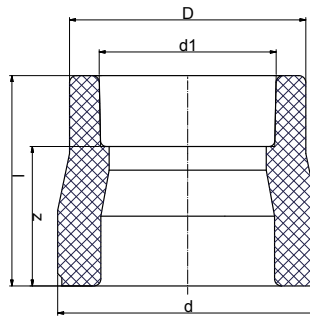

SDR	Art.-No.	Dimension d [mm]	Dimension d1 [mm]	l	z	D	Weight [kg]	PU	Box unit	Price € m/pc
double-sided socket welding										
6 7,4 9 11 17,6	11112	25	20,00	38,50	24,00	29,50	0,012	10	1500	
	11114	32	20,00	37,50	23,00	29,50	0,015	5	1000	
	11116	32	25,00	38,00	22,00	34,00	0,016	5	1000	
	11118	40	20,00	45,00	30,50	29,50	0,025	5	750	
	11120	40	25,00	50,00	34,00	34,00	0,028	5	600	
	11122	40	32,00	50,00	32,00	43,00	0,032	5	500	
	11124	50	20,00	55,00	40,50	29,50	0,045	5	500	
	11126	50	25,00	55,00	39,00	34,00	0,044	5	500	
	11128	50	32,00	54,00	36,00	43,00	0,048	5	350	
	11130	50	40,00	52,50	32,00	52,00	0,053	5	300	
	11131	63	20,00	65,00	50,50	29,50	0,073	1	200	
	11132	63	25,00	65,00	49,00	34,00	0,071	1	200	
	11134	63	32,00	62,00	44,00	43,00	0,076	1	200	
	11136	63	40,00	65,00	44,50	52,00	0,089	1	200	
	11138	63	50,00	63,50	40,00	68,00	0,107	1	150	
	11139	75	40,00	69,50	49,00	52,00	0,130	1	150	
	11140	75	50,00	63,00	39,50	68,00	0,141	1	100	
	11142	75	63,00	71,00	43,50	84,00	0,171	1	100	
	11143	75	20,00	65,50	51,00	34,50	0,115	1	200	
	11144	75	25,00	65,50	49,50	34,50	0,109	1	200	
11145	75	32,00	69,50	51,50	52,00	0,140	1	150		
11151	90	50,00	75,00	51,50	68,00	0,196	1	100		
11152	90	63,00	78,00	50,50	84,00	0,226	1	75		
11153	90	75,00	81,50	51,50	100,00	0,272	1	60		
11155	110	63,00	86,00	58,50	84,00	0,356	1	50		
11157	110	75,00	89,00	59,00	100,00	0,383	1	50		
11159	110	90,00	99,00	66,00	120,00	0,502	1	40		
11161	125	75,00	101,00	71,00	100,00	0,528	1	35		
11163	125	90,00	99,00	66,00	120,00	0,588	1	35		
11165	125	110,00	112,00	75,00	147,00	0,833	1	25		

REDUCING SOCKET, SOCKET & BUTT WELDING

Material: Fusiolen® PP-R & PP-RP
 Standard: DIN 16962, DIN EN ISO 15874
 Colour: green

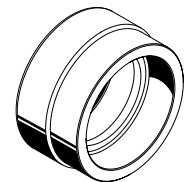
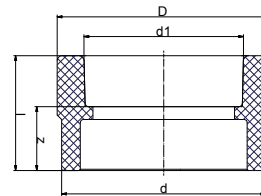

SDR	Art.-No.	Dimension d [mm]	Dimension d1 [mm]	l	z	D	Weight [kg]	PU	Box unit	Price € m/pc
onesided socket welding, other side butt welding										
11	111175	160	110,00	90,00	53,00	147,00	0,595	1	25	
	111177	160	125,00	90,00	50,00	167,00	0,705	1	20	
	111183	200	125,00	135,00	95,00	167,00	1,358	1		
17,6	2511174	160	110,00	90,00	53,00	147,00		1	25	
	2511176	160	125,00	90,00	50,00	167,00	0,628	1	25	
	2511182	200	125,00	135,00	95,00	167,00	1,055	1		

REDUCING SOCKET, BUTT WELDING

Material: Fusiolen® PP-R & PP-RP
 Standard: DIN 16962, DIN EN ISO 15874
 Colour: green

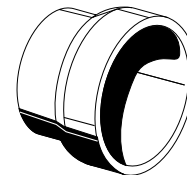
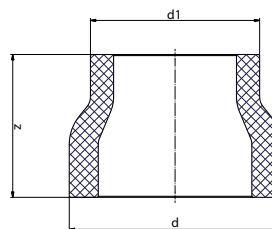

SDR	Art.-No.	Dimension d [mm]	Dimension d1 [mm]	z	Weight [kg]	PU	Box unit	Price € m/pc
double-sided butt welding								
11	11185	200	160,00	135,00	1,163	1	12	
	11189	250	160,00	172,50	3,472	1	5	
	11191	250	200,00	172,50	2,341	1	5	
	11193	315	200,00	225,00	3,412	1		
	11195	315	250,00	233,00	4,650	1	1	
	11197	355	250,00	245,00	3,940	1		
	11199	355	315,00	160,00	4,344	1	3	
	11201	400	250,00	260,00		1		
	11203	400	315,00	260,00		1		
	11204	400	355,00	260,00		1		
	11206	450	315,00	230,00		1		
	11207	450	355,00	230,00		1		
	11208	450	400,00	230,00		1		

REDUCING SOCKET, BUTT WELDING

Material: Fusiolen® PP-R
 Standard: DIN 16962, DIN EN ISO 15874
 Colour: green

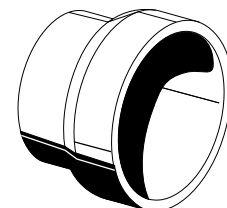
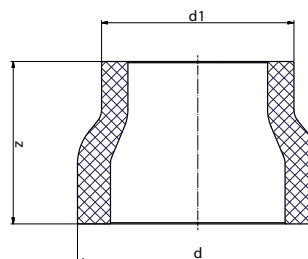

SDR	Art.-No.	Dimension d [mm]	Dimension d1 [mm]	z	Weight [kg]	PU	Box unit	Price € m/pc
double-sided butt welding								
17,6	2511184	200	160,00	135,00	0,786	1		
	2511188	250	160,00	172,50	1,500	1		
	2511190	250	200,00	172,50	1,338	1		
	2511193	315	200,00	225,00		1		
	2511195	315	250,00	225,00		1		
	2511197	355	250,00	245,00	3,099	1		
	2511199	355	315,00	160,00	3,108	1		
	2511201	400	250,00	260,00	4,482	1		
	2511203	400	315,00	260,00	3,366	1		
	2511204	400	355,00	260,00	2,982	1		
	2511206	450	315,00	230,00	4,891	1		
	2511207	450	355,00	230,00	4,688	1		
	2511208	450	400,00	230,00	4,287	1		
	2511209	500	315,00	230,00	8,100	1		
	2511210	500	355,00	230,00	6,500	1		
	2511211	500	400,00	230,00	6,700	1		
	2511212	500	450,00	230,00	5,500	1		
	2511213	560	400,00	230,00	9,000	1		
	2511214	560	450,00	200,00	8,600	1		
	2511215	560	500,00	200,00	7,600	1		
2511216	630	400,00	230,00	15,100	1			
2511217	630	450,00	200,00	13,700	1			
2511218	630	500,00	200,00	11,000	1			
2511219	630	560,00	200,00	9,000	1			

ELBOW 90°

Material: Fusiolen® PP-R
 Standard: DIN 16962, DIN EN ISO 15874
 Colour: green

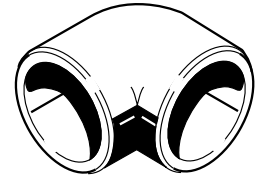
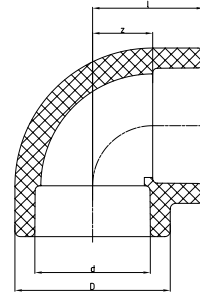

SDR	Art.-No.	Dimension d [mm]	z	l	D	Weight [kg]	PU	Box unit	Price € m/pc
socket welding									
6 7,4 9 11 17,6	12108	20	11,00	25,50	29,50	0,018	10	1200	
	12110	25	13,50	29,50	34,00	0,023	10	800	
	12112	32	17,00	35,00	43,00	0,043	5	400	
	12114	40	21,00	41,50	52,00	0,071	5	250	
	12116	50	26,00	49,50	68,00	0,163	5	125	
	12118	63	32,50	60,00	84,00	0,290	1	75	
	12120	75	38,50	68,50	100,00	0,446	1	40	
	12122	90	46,00	79,00	120,00	0,743	1	25	
	12124	110	56,00	93,00	147,00	1,282	1	15	
12126	125	76,50	116,50	167,00	2,006	1	10		

ELBOW 90° BUTT WELDING

Material: Fusiolen® PP-R & PP-RP
 Standard: DIN 16962, DIN EN ISO 15874
 Notice: Electrofusion sockets are not applicable with 160 mm fittings

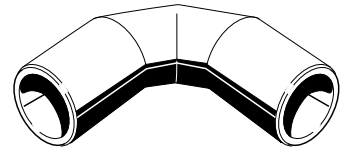
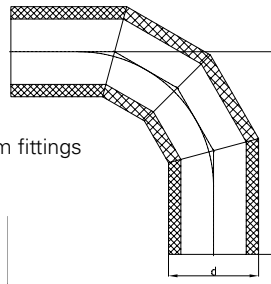

SDR	Art.-No.	Dimension d [mm]	z	Weight [kg]	PU	Box unit	Price € m/pc
butt welding							
11	12131	160	145,00	1,912	1	8	
1) mechanically stabilized through a fibre mix integrated in the middle layer of the fusiolen® PP-R							
11	2012135	200	450,00	8,014	1		
	2012139	250	625,00	18,000	1		
	2012143	315	773,00	37,300	1		
	2012145	355	833,00	26,650	1		
	2012147	400	900,00	74,500	1		
	2012149	450	975,00		1		
17,6	2512130	160	390,00	3,200	1		
	2512134	200	450,00		1		
	2512138	250	625,00		1		
	2512142	315	773,00	24,000	1		
	2512144	355	833,00	32,000	1		
	2512146	400	900,00		1		
	2512148	450	975,00		1		
	2512150	500	1100,00		1		
	2512152	560	1190,00		1		
2512154	630	1295,00		1			

ELBOW 90° FEMALE/MALE

Material: Fusiolen® PP-R
 Standard: DIN 16962, DIN EN ISO 15874
 Colour: green

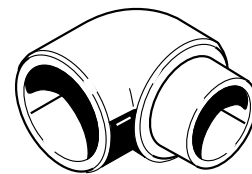
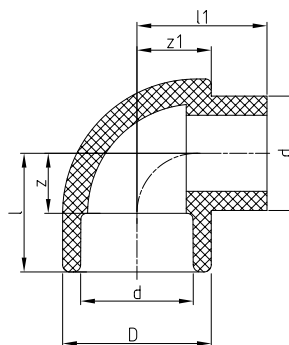

SDR	Art.-No.	Dimension d [mm]	z	l	D	l1	z1	Weight [kg]	PU	Box unit	Price € m/pc
socket welding											
7,4 11	12306	16	9,00	22,00	24,50	21,75	12,00	0,010	10	2000	
	12308	20	11,00	25,50	29,50	25,50	15,00	0,017	10	1200	
	12310	25	13,50	29,50	34,00	29,50	17,00	0,023	10	800	
	12312	32	17,00	35,00	43,00	39,00	21,50	0,047	5	500	
	12314	40	21,00	41,50	52,00	45,50	26,00	0,080	5	300	

ELBOW 45° FEMALE/MALE

Material: Fusiolen® PP-R
 Standard: DIN 16962, DIN EN ISO 15874
 Colour: green

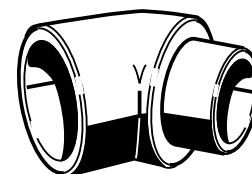
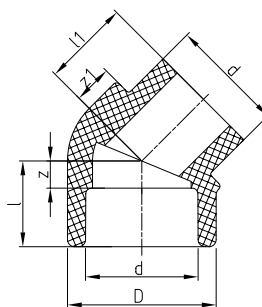

SDR	Art.-No.	Dimension d [mm]	z	l	D	l1	z1	Weight [kg]	PU	Box unit	Price € m/pc
socket welding											
7,4 11	12708	20	5,00	19,50	29,50	19,50	9,00	0,013	10	1500	
	12710	25	6,00	22,00	34,00	22,00	8,50	0,017	10	1000	
	12712	32	7,50	25,50	43,00	28,50	11,50	0,036	5	500	
	12714	40	9,50	30,00	52,00	30,50	13,50	0,057	5	300	

ELBOW 45° SOCKET WELDING

Material: Fusiolen® PP-R
 Standard: DIN 16962, DIN EN ISO 15874
 Colour: green

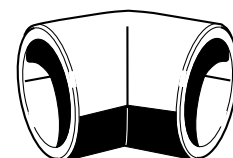
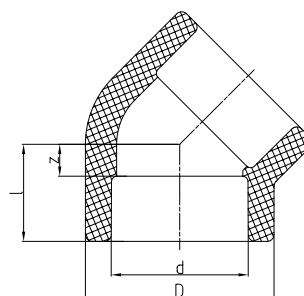

SDR	Art.-No.	Dimension d [mm]	z	l	D	Weight [kg]	PU	Box unit	Price € m/pc
socket welding									
7,4 11 17,6	12508	20	5,00	19,50	29,50	0,014	10	1500	
	12510	25	6,00	22,00	34,00	0,018	10	1000	
	12512	32	7,50	25,50	43,00	0,035	5	500	
	12514	40	9,50	30,00	52,00	0,053	5	300	
	12516	50	11,50	35,00	68,00	0,113	5	150	
	12518	63	14,00	41,50	84,00	0,226	1	75	
	12520	75	16,50	46,50	100,00	0,350	1	60	
	12522	90	19,50	52,50	120,00	0,571	1	30	
	12524	110	23,50	60,50	147,00	1,022	1	20	
	12526	125	27,00	67,00	167,00	1,309	1	15	

ELBOW 45° BUTT WELDING

Material: Fusiolen® PP-R & PP-RP
 Standard: DIN 16962, DIN EN ISO 15874
 Notice: Electrofusion sockets are not applicable with 160 mm fittings

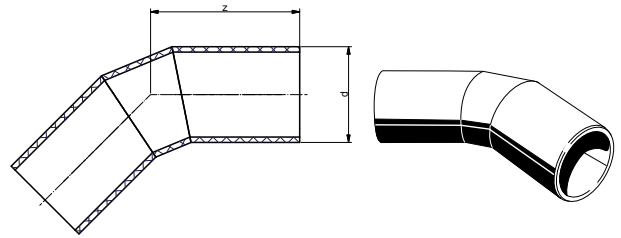

SDR	Art.-No.	Dimension d [mm]	z	Weight [kg]	PU	Box unit	Price € m/pc
butt welding							
11	12531	160	95,00	1,380	1		
1) MECHANICALLY STABILIZED THROUGH A FIBRE MIX INTEGRATED IN THE MIDDLE LAYER OF THE FUSIOLEN® PP-R							
11	2012535	200	274,00	6,865	1		
	2012539	250	412,00	16,000	1		
	2012543	315	517,00	27,100	1		
	2012545	355	520,00	42,000	1		
	2012547	400	548,00		1		
	2012549	450	580,00		1		
17,6	2512530	160	249,00	1,730	1		
	2512534	200	274,00		1		
	2512538	250	412,00	9,400	1		
	2512542	315	498,00	18,000	1		
	2512544	355	520,00		1		
	2512546	400	548,00	30,800	1		
	2512548	450	580,00		1		
	2512550	500	665,00		1		
	2512552	560	698,00		1		
	2512554	630	741,00		1		

T-PIECE SOCKET WELDING

Material: Fusiolen® PP-R
 Standard: DIN 16962, DIN EN ISO 15874
 Colour: green

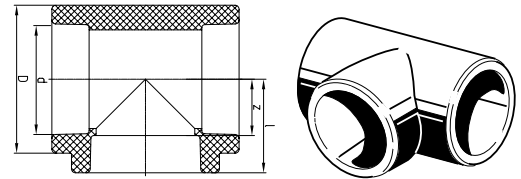

SDR	Art.-No.	Dimension d [mm]	z	l	D	Weight [kg]	PU	Box unit	Price € m/pc
socket welding									
7,4 11 17,6	13108	20	11,00	25,50	29,50	0,022	10	1000	
	13110	25	15,00	31,00	34,00	0,033	10	500	
	13112	32	17,00	35,00	43,00	0,054	5	300	
	13114	40	20,00	40,50	52,00	0,099	5	200	
	13116	50	26,00	49,50	68,00	0,175	5	100	
	13118	63	32,50	60,00	84,00	0,371	1	50	
	13120	75	38,50	68,50	100,00	0,540	1	30	
	13122	90	46,00	79,00	120,00	0,924	1	25	
	13124	110	56,00	93,00	147,00	1,611	1	14	
	13126	125	76,50	116,50	167,00	2,655	1	8	

T- PIECE BUTT WELDING

Material: Fusiolen® PP-R & PP-RP
 Standard: DIN 16962, DIN EN ISO 15874
 Notice: Electrofusion sockets are not applicable with 160 mm fittings

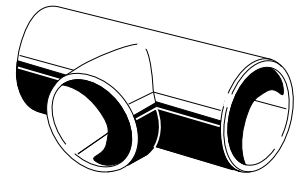
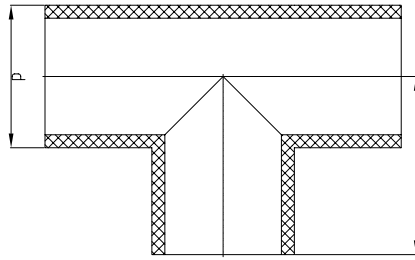

SDR	Art.-No.	Dimension d [mm]	z	Weight [kg]	PU	Box unit	Price € m/pc
butt welding							
11	13131	160	145,00	2,791	1	5	
1) mechanically stabilized through a fibre mix integrated in the middle layer of the fusiolen® PP-R							
11	2013135	200	250,00	6,865	1		
	2013139	250	375,00	16,000	1		
	2013143	315	460,00	20,450	1		
	2013145	355	480,00	42,000	1		
	2013147	400	500,00		1		
	2013149	450	525,00		1		
17,6	2513130	160	145,00	2,716	1		
	2513134	200	250,00		1		
	2513138	250	375,00	11,500	1		
	2513142	315	460,00	22,000	1		
	2513144	355	480,00	27,500	1		
	2513146	400	500,00		1		
	2513148	450	525,00		1		
	2513150	500	600,00		1		
	2513152	560	630,00		1		
	2513154	630	665,00		1		

RED.- T-PIECE, SOCKET WELDING

Material: Fusiolen® PP-R
 Standard: DIN 16962, DIN EN ISO 15874
 Colour: green

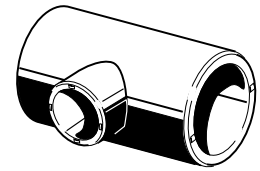
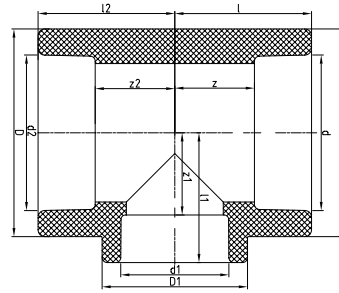

SDR	Art.-No.	d	d1	d2	l	l1	l2	z	z1	z2	D	D1	Weight [kg]	PU	Box unit	Price € m/pc
socket welding																
7,4 11 17,6	13511	20	25,00	20,00	31,00	30,50	31,00	16,50	14,50	16,50	34,00	34,00	0,040	10	500	
	13520	25	20,00	20,00	31,00	30,50	31,00	15,00	16,00	16,50	34,00	34,00	0,039	10	500	
	13522	25	20,00	25,00	31,00	30,50	31,00	15,00	16,00	15,00	34,00	34,00	0,036	10	500	
	13528	32	16,00	32,00	35,00	31,00	35,00	17,00	18,00	17,00	43,00	29,50	0,053	5	300	
	13532	32	20,00	20,00	36,50	37,00	36,50	18,75	22,50	22,25	43,00	43,00	0,075	5	300	
	13534	32	20,00	32,00	35,00	31,00	35,00	17,00	16,50	17,00	43,00	29,50	0,049	5	300	
	13538	32	25,00	25,00	35,00	34,50	35,00	17,00	18,50	15,00	43,00	43,00	0,069	5		
	13540	32	25,00	32,00	35,00	34,50	35,00	17,00	18,50	17,00	43,00	43,00	0,050	5	300	
	13542	40	20,00	40,00	41,50	36,00	41,50	21,00	21,50	21,00	52,00	34,00	0,091	5	200	
	13544	40	25,00	40,00	41,50	36,00	41,50	21,00	20,00	21,00	52,00	34,00	0,090	5	200	
	13546	40	32,00	40,00	42,00	40,50	42,00	21,50	22,50	21,50	52,00	52,00	0,092	5	200	
	13547	50	20,00	50,00	49,50	40,50	49,50	26,00	26,00	26,00	68,00	29,50	0,161	5	100	
	13548	50	25,00	50,00	49,50	44,50	49,50	26,00	28,50	26,00	68,00	43,00	0,158	5	100	
	13550	50	32,00	50,00	49,50	44,50	49,50	26,00	26,50	26,00	68,00	43,00	0,159	5	100	
	13551	50	40,00	50,00	49,50	49,50	49,50	26,00	29,00	26,00	68,00	68,00	0,161	5	100	
	13552	63	20,00	63,00	60,00	48,50	60,00	32,50	34,00	32,50	84,00	34,00	0,334	1	50	
	13554	63	25,00	63,00	60,00	48,50	60,00	32,50	32,50	32,50	84,00	34,00	0,329	1	50	
	13556	63	32,00	63,00	60,00	53,50	60,00	32,50	35,50	32,50	84,00	52,00	0,342	1	50	
	13558	63	40,00	63,00	60,00	53,50	60,00	32,50	33,00	32,50	84,00	52,00	0,333	1	50	
	13560	63	50,00	63,00	60,00	60,00	60,00	32,50	36,50	32,50	84,00	84,00	0,402	1	50	
	13561	75	20,00	75,00	68,50	54,50	68,50	38,50	40,00	38,50	100,00	34,00	0,501	1	35	
	13562	75	25,00	75,00	68,50	54,50	68,50	38,50	38,50	38,50	100,00	34,00	0,497	1	35	
	13564	75	32,00	75,00	68,50	59,00	68,50	38,50	41,00	38,50	100,00	52,00	0,506	1	35	
	13566	75	40,00	75,00	68,50	59,00	68,50	38,50	38,50	38,50	100,00	52,00	0,496	1	35	
	13568	75	50,00	75,00	68,50	66,00	68,50	38,50	42,50	38,50	100,00	84,00	0,553	1	35	
	13570	75	63,00	75,00	68,50	66,00	68,50	38,50	38,50	38,50	100,00	84,00	0,518	1	35	
	13576 ¹⁾	90	32,00	90,00	79,00	65,00	79,00	46,00	47,00	46,00	120,00	52,00	0,882	1	25	
	13578 ¹⁾	90	40,00	90,00	79,00	65,00	79,00	46,00	44,50	46,00	120,00	52,00	0,870	1	25	
13580 ¹⁾	90	50,00	90,00	79,00	75,00	79,00	46,00	51,50	46,00	120,00	84,00	0,908	1	25		
13582 ¹⁾	90	63,00	90,00	79,00	75,00	79,00	46,00	47,50	46,00	120,00	84,00	0,874	1	25		
13584 ¹⁾	90	75,00	90,00	79,00	81,00	79,00	46,00	51,00	46,00	120,00	120,00	0,993	1	25		
13586 ¹⁾	110	63,00	110,00	93,00	87,50	93,00	56,00	60,00	56,00	147,00	100,00	1,567	1	15		
13588 ¹⁾	110	75,00	110,00	93,00	87,50	93,00	56,00	57,50	56,00	147,00	100,00	1,501	1	15		
13590 ¹⁾	110	90,00	110,00	93,00	89,00	93,00	56,00	56,00	56,00	147,00	120,00	1,534	1	15		
13592 ¹⁾	125	75,00	125,00	116,50	106,50	116,50	76,50	76,50	76,50	167,00	100,00	2,421	1	8		
13594 ¹⁾	125	90,00	125,00	116,50	109,50	116,50	76,50	76,50	76,50	167,00	120,00	2,519	1	8		
13596 ¹⁾	125	110,00	125,00	116,50	113,50	116,50	76,50	76,50	76,50	167,00	147,00	2,563	1	8		

1) MECHANICALLY STABILIZED THROUGH A FIBRE MIX INTEGRATED IN THE MIDDLE LAYER OF THE FUSIOLEN® PP-R

RED.- T-PIECE, SOCKET- & BUTT WELDING

Material: Fusiolen® PP-R & PP-RP
 Standard: DIN 16962, DIN EN ISO 15874
 Branch: socket welding

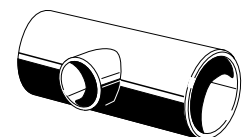
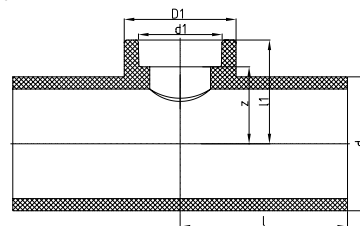

SDR	Art.-No.	d	d1	l	l1	z	D	Weight [kg]	PU	Box unit	Price € m/pc
branch: socket welding											
11	13601	160	75,00	230,00	122,00	92,00	100,00	3,140	1	4	
	13603	160	90,00	230,00	125,00	92,00	120,00	3,176	1	4	

aquatherm blue pipe RED.- T-PIECE, SOCKET- & BUTT WELDING

Material: Fusiolen® PP-R
 Standard: DIN 16962, DIN EN ISO 15874
 Colour: blue/green
 Branch: socket welding

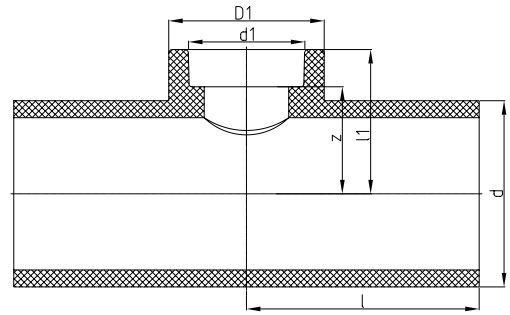
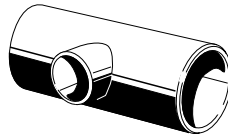

SDR	Art.-No.	d	d1	l	l1	z	D	Weight [kg]	PU	Box unit	Price € m/pc
11	Branch: socket welding										
	2013609	200	75,00	250,00	142,00	112,00	100,00		1		
	2013611	200	90,00	250,00	145,00	112,00	120,00		1		
	2013613	200	110,00	250,00	149,00	112,00	147,00		1		
	2013615	200	125,00	250,00	155,00	115,00	167,00		1		
	2013625	250	75,00	375,00	167,00	137,00	100,00		1		
	2013627	250	90,00	375,00	170,00	137,00	120,00		1		
	2013629	250	110,00	375,00	174,00	137,00	147,00		1		
	2013631	250	125,00	375,00	180,00	140,00	167,00		1		
	2013651	315	125,00	460,00	213,00	173,00	167,00	25,000	1		
	2013663	355	125,00	480,00	233,00	193,00	167,00		1		
2013676	400	125,00	500,00	255,00	215,00	167,00		1			
2013690	450	125,00	525,00	280,00	240,00	167,00		1			

aquatherm blue pipe RED.- T-PIECE, BUTT WELDING

Material: Fusiolen® PP-R
 Standard: DIN 16962, DIN EN ISO 15874
 Colour: blue/green
 Branch: butt welding

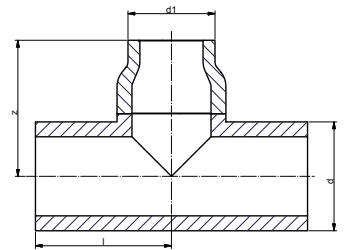
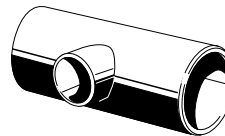

SDR	Art.-No.	d	d1	l	z	Weight [kg]	PU	Box unit	Price € m/pc	
11	Branch: butt welding									
	2013619	200	160,00	250,00	250,00		1			
	2013635	250	160,00	375,00	682,00		1			
	2013641	250	200,00	375,00	548,00		1			
	2013653	315	160,00	460,00	238,00	25,000	1			
	2013655	315	200,00	460,00	460,00		1			
	2013657	315	250,00	460,00	460,00		1			
	2013665	355	160,00	480,00	258,00		1			
	2013667	355	200,00	480,00	268,00	30,200	1			
	2013669	355	250,00	480,00	480,00	40,000	1			
	2013671	355	315,00	480,00	480,00	40,000	1			
	2013678	400	160,00	500,00	354,00		1			
	2013680	400	200,00	500,00	318,00		1			
	2013682	400	250,00	500,00	280,00	46,000	1			
	2013684	400	315,00	500,00	500,00		1			
	2013685	400	355,00	500,00	500,00		1			
	2013692	450	160,00	525,00	379,00		1			
	2013694	450	200,00	525,00	343,00		1			
	2013696	450	250,00	525,00	305,00		1			
	2013698	450	315,00	525,00	315,00		1			
2013699	450	355,00	525,00	525,00		1				
2013700	450	400,00	525,00	525,00		1				

aquatherm blue pipe RED.- T-PIECE SOCKET- & BUTT WELDING

Material: Fusiolen® PP-R
 Standard: DIN 16962, DIN EN ISO 15874
 Colour: blue
 Branch: socket welding

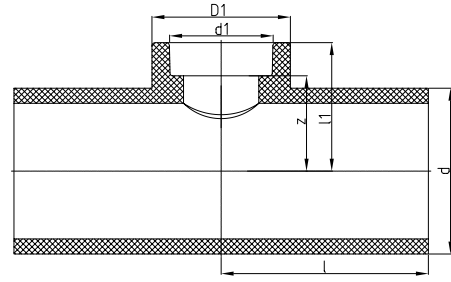
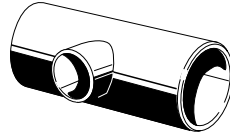

SDR	Art.-No.	d	d1	l	l1	z	D	Weight [kg]	PU	Box unit	Price € m/pc
17,6	Branch: socket welding										
	2513600	160	75,00	230,00	122,00	92,00	100,00		1		
	2513602	160	90,00	230,00	125,00	92,00	120,00		1		
	2513608	200	75,00	250,00	142,00	112,00	100,00		1		
	2513610	200	90,00	250,00	145,00	112,00	120,00		1		
	2513612	200	110,00	250,00	149,00	112,00	147,00		1		
	2513614	200	125,00	250,00	155,00	115,00	167,00		1		
	2513624	250	75,00	375,00	167,00	137,00	100,00		1		
	2513626	250	90,00	375,00	170,00	137,00	120,00		1		
	2513628	250	110,00	375,00	174,00	137,00	147,00		1		
	2513630	250	125,00	375,00	180,00	140,00	167,00		1		
	2513651	315	125,00	460,00	213,00	173,00	167,00		1		
	2513663	355	125,00	480,00	233,00	193,00	167,00	21,500	1		
	2513676	400	125,00	500,00	255,00	215,00	167,00		1		
	2513690	450	125,00	525,00	280,00	240,00	167,00		1		
2513804	500	125,00	600,00	305,00	265,00	167,00		1			
2513821	560	125,00	630,00	335,00	295,00	167,00		1			
2513839	630	125,00	665,00	370,00	330,00	167,00		1			

aquatherm blue pipe RED.- T-PIECE, BUTT WELDING

Standard: DIN 16962, DIN EN ISO 15874
 Colour: blue
 Branch: butt welding

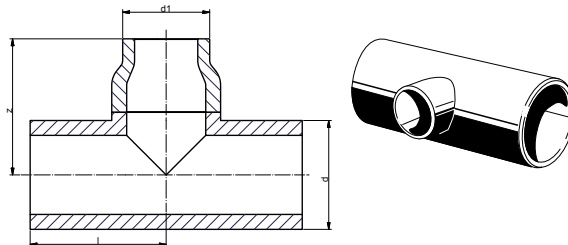

SDR	Art.-No.	d	d1	l	z	Weight [kg]	PU	Box unit	Price € m/pc
17,6	butt welding								
	2513618	200	160,00	250,00	250,00		1		
	2513634	250	160,00	375,00	375,00		1		
	2513640	250	200,00	375,00	375,00		1		
	2513653	315	160,00	460,00	238,00		1		
	2513655	315	200,00	460,00	460,00		1		
	2513657	315	250,00	460,00	460,00		1		
	2513665	355	160,00	480,00	258,00	21,500	1		
	2513667	355	200,00	480,00	268,00		1		
	2513669	355	250,00	480,00	480,00		1		
	2513671	355	315,00	480,00	480,00		1		
	2513678	400	160,00	500,00	354,00		1		
	2513680	400	200,00	500,00	318,00		1		
	2513682	400	250,00	500,00	280,00	29,000	1		
	2513684	400	315,00	500,00	500,00	35,800	1		
	2513685	400	355,00	500,00	500,00		1		
	2513692	450	160,00	525,00	379,00		1		
	2513694	450	200,00	525,00	343,00		1		
	2513696	450	250,00	525,00	305,00		1		
	2513698	450	315,00	525,00	315,00		1		
	2513699	450	355,00	525,00	525,00		1		
	2513700	450	400,00	525,00	525,00		1		
	2513806	500	160,00	600,00	404,00		1		
	2513808	500	200,00	600,00	368,00		1		
	2513810	500	250,00	600,00	330,00		1		
	2513812	500	315,00	600,00	340,00		1		
	2513813	500	355,00	600,00	600,00		1		
	2513814	500	400,00	600,00	600,00		1		
	2513815	500	450,00	600,00	600,00		1		
	2513823	560	160,00	630,00	434,00		1		
	2513825	560	200,00	630,00	398,00		1		
	2513827	560	250,00	630,00	360,00		1		
	2513829	560	315,00	630,00	370,00		1		
2513830	560	355				1			
2513831	560	400,00	630,00	630,00		1			
2513832	560	450,00	630,00	630,00		1			
2513833	560	500,00	630,00	630,00		1			
2513841	630	160,00	665,00	474,00		1			
2513843	630	200,00	665,00	438,00		1			
2513845	630	250,00	665,00	400,00		1			
2513847	630	315,00	665,00	405,00		1			
2513848	630	355				1			
2513849	630	400,00	665,00	665,00		1			
2513850	630	450,00	665,00	665,00		1			
2513851	630	500,00	665,00	665,00		1			
2513852	630	560,00	665,00	665,00		1			

CROSS

Material: Fusiolen® PP-R
 Standard: DIN 16962, DIN EN ISO 15874
 Colour: green

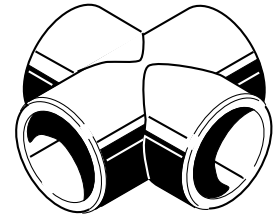
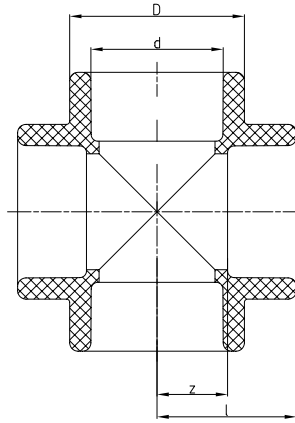

SDR	Art.-No.	Dimension d [mm]	z	l	D	Weight [kg]	PU	Box unit	Price € m/pc
7,4 11	socket welding								
	13708	20	26,00	11,50	29,50	0,025	10	500	
	13710	25	29,50	13,50	34,00	0,035	10	500	
	13712	32	35,00	17,00	43,00	0,064	5	250	
	13714	40	41,50	21,00	52,00	0,099	5	150	

CROSS OVER FITTING

Material: Fusiolen® PP-R
 Standard: DIN 16962, DIN EN ISO 15874
 Colour: green

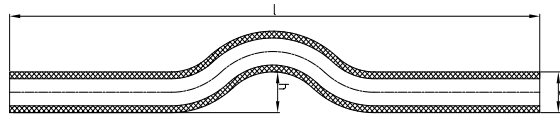

SDR	Art.-No.	Dimension d [mm]	h	l	Weight [kg]	PU	Box unit	Price € m/pc	
7,4 11	socket welding								
	16106	16	17,00	352,00	0,038	10	600		
	16108	20	22,00	352,00	0,060	10	400		
	16110	25	25,00	352,00	0,091	10	250		
	16112	32	32,00	352,00	0,154	5	120		

END CAP

Material: Fusiolen® PP-R & PP-RP
 Standard: DIN 16962, DIN EN ISO 15874
 Colour: green

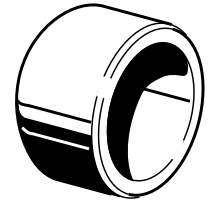
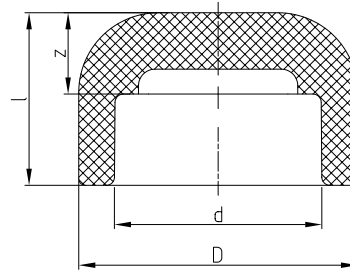

SDR	Art.-No.	Dimension d [mm]	l	z	D	Weight [kg]	PU	Box unit	Price € m/pc
socket welding									
7,4 11	14108	20	24,00	9,50	29,50	0,009	10	2000	
	14110	25	24,00	8,00	34,00	0,011	10	1500	
	14112	32	31,50	13,50	43,00	0,019	5	1000	
	14114	40	38,00	17,50	52,00	0,043	5	500	
	14116	50	44,50	21,00	68,00	0,081	5	300	
	14118	63	52,00	24,50	84,00	0,144	1	150	
	14120	75	58,50	28,50	100,00	0,243	1	90	
	14122	90	57,50	34,50	120,00	0,368	1	60	
	14124	110	65,00	28,00	147,00	0,635	1	40	
14126	125	70,00	30,00	167,00	0,862	1	30		
butt welding									
7,4	14130	160	70,00			0,914	1	30	
	14134	200	80,00			1,378	1	24	
	14138	250	90,00			2,530	1	10	
11	14131	160	70,00			0,818	1	30	
	14135	200	80,00			1,070	1	24	
	14139	250	90,00			1,989	1	10	
	14143	315	270,00			6,200	1		
	14145	355	65,00			9,500	1		
	14147	400	60,00				1		
	14149	450	70,00				1		
17,6	2514130	160				0,679	1		
	2514134	200				0,925	1		
	2514138	250				2,109	1		
	2514142	315				2,961	1		
	2514144	355				3,930	1		
	2514146	400	60,00			5,821	1		
	2514148	450	70,00			8,520	1		
	2514150	500	75,00			12,500	1		
	2514152	560	80,00			16,000	1		
	2514154	630	90,00			23,500	1		

WELD-IN SADDLE

Material: Fusiolen® PP-R
 Standard: DIN 16962, DIN EN ISO 15874
 Colour: green

Notice *do not use with aquatherm blue pipe OT

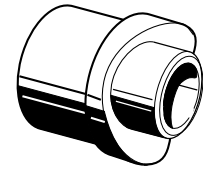
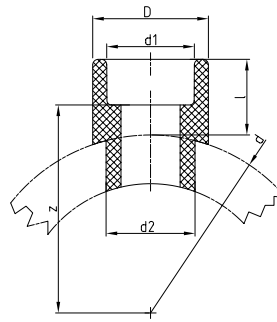

SDR	Art.-No.	d	d1	d2	l	z	D	Weight [kg]	PU	Box unit	Price € m/pc
	socket welding										
7,4 11 17,6	15156*	40	20,00	25,00	27,00	32,50	29,50	0,016	5	1000	
	15158*	40	25,00	25,00	28,50	32,50	34,00	0,017	5	1000	
	15160	50	20,00	25,00	27,50	38,00	29,50	0,018	5	1000	
	15162	50	25,00	25,00	28,50	37,50	34,00	0,019	5	1000	
	15164	63	20,00	25,00	27,50	44,50	29,50	0,017	5	1000	
	15166	63	25,00	25,00	28,50	44,00	34,00	0,019	5	750	
	15168	63	32,00	32,00	30,00	43,50	43,00	0,028	5	750	
	15170	75	20,00	25,00	27,50	50,50	29,50	0,018	5	1000	
	15172	75	25,00	25,00	28,50	50,00	34,00	0,019	5	750	
	15174	75	32,00	32,00	30,00	49,50	43,00	0,028	5	750	
	15175	75	40,00	40,00	34,00	51,00	52,00	0,049	5	400	
	15176	90	20,00	25,00	27,50	58,00	29,50	0,018	5	1000	
	15178	90	25,00	25,00	28,50	57,50	34,00	0,019	5	1000	
	15180	90	32,00	32,00	30,00	57,00	43,00	0,029	5	750	
	15181	90	40,00	40,00	34,00	58,50	52,00	0,048	5	500	
	15182	110	20,00	25,00	27,50	68,00	29,50	0,019	5	1000	
	15184	110	25,00	25,00	28,50	68,50	34,00	0,020	5	1000	
	15186	110	32,00	32,00	30,00	67,00	43,00	0,030	5	750	
	15188	110	40,00	40,00	34,00	68,50	52,00	0,050	5	450	
	15189	110	50,00	50,00	34,00	65,50	68,00	0,091	5	200	
	15190	125	20,00	25,00	27,50	75,50	67,00	0,019	5	1000	
	15192	125	25,00	25,00	28,50	75,00	34,00	0,020	5	1000	
	15194	125	32,00	32,00	30,00	74,50	43,00	0,029	5	750	
	15196	125	40,00	40,00	34,00	76,00	52,00	0,050	5	450	
	15197	125	50,00	50,00	34,00	73,00	68,00	0,091	5	200	
	15198	125	63,00	63,00	38,00	73,00	84,00	0,150	5	125	
	15206	160	20,00	25,00	27,50	93,00	29,50	0,021	5	700	
	15208	160	25,00	25,00	28,50	92,50	34,00	0,023	5	700	
	15210	160	32,00	32,00	30,00	92,00	43,00	0,034	5	500	
	15212	160	40,00	40,00	34,00	93,50	52,00	0,054	5	300	
	15214	160	50,00	50,00	34,00	90,50	84,00	0,093	5	200	
	15216	160	63,00	63,00	38,00	90,50	84,00	0,155	5	120	
	15218	160	75,00	75,00	42,00	92,00	100,00	0,227	5	80	
	15220	160	90,00	90,00	45,00	92,00	120,00	0,364	5	40	
15228	200-250	20,00	25,00	27,50	113,00	29,50	0,020	5	100		
15229	200-250	25,00	25,00	28,50	112,50	34,00	0,021	5	100		
15230	200-250	32,00	32,00	30,00	112,00	43,00	0,031	5	50		
15231	200	40,00	40,00	34,00	113,50	52,00	0,049	5	200		
15232	200	50,00	50,00	34,00	110,50	68,00	0,087	5	200		
15233	200	63,00	63,00	37,50	110,00	84,00	0,147	5	120		
15234	200	75,00	75,00	42,00	112,00	100,00	0,220	5	100		
15235	200	90,00	90,00	45,00	112,00	120,00	0,342	5	5		
15236	200	110,00	110,00	49,00	112,00	147,00	0,577	5	2		
15237	200	125,00	125,00	55,00	115,00	167,00	0,869	5	20		
15251	250	40,00	40,00	34,00	138,50	52,00	0,053	5	150		
15252	250	50,00	50,00	34,00	135,50	68,00	0,090	5	100		
15253	250	63,00	63,00	37,50	135,00	84,00	0,152	5	140		
15254	250	75,00	75,00	42,00	137,00	100,00	0,222	5	5		
15255	250	90,00	90,00	45,00	137,00	120,00	0,348	5	5		
15256	250	110,00	110,00	49,00	137,00	147,00	0,054	5	20		
15257	250	125,00	125,00	55,00	140,00	167,00	0,820	5	20		

WELD-IN SADDLES

Material: Fusiolen® PP-R
 Standard: DIN 16962, DIN EN ISO 15874
 Colour: green

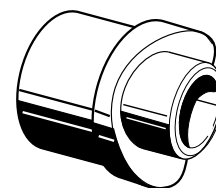
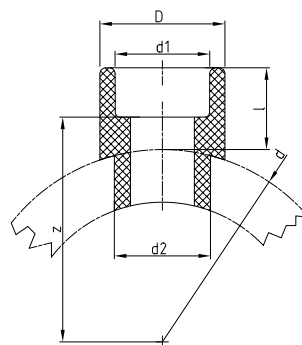

SDR	Art.-No.	d	d1	d2	l	z	D	Weight [kg]	PU	Box unit	Price € m/pc
socket welding											
7,4 11 17,6	15260	315-355	63,00	63,00	37,50	167,50	84,00	0,153	1		
	15261	315-355	75,00	75,00	42,00	169,50	100,00	0,230	1		
	15262	315	90,00	90,00	45,00	169,50	120,00	0,347	1		
	15263	315	110,00	110,00	49,00	169,50	147,00	0,567	1		
	15264	315	125,00	125,00	55,00	172,50	167,00	0,830	1		
	15268	355	90,00	90,00	45,00	189,5	120,00	0,355	1		
	15269	355	110,00	110,00	49,00	189,5	147,00	0,586	1		
	15270	355	125,00	125,00	55,00	192,5	167,00	0,803	1		
	15275	400-500	75,00	75,00	42,00	212,00	100,00	0,209	1		
	15277	400-450	110,00	110,00	49,00	212,00	147,00	0,528	1		
	15278	400	125,00	125,00	55,00	215,00	167,00	0,769	1		
	15288	400-500	90,00	90,00	45,00	237,00	120,00	0,326	1		
	15290	450-500	125,00	125,00	55,00	240,00	167,00	0,774	1		
	15300	400-630	63,00	63,00	37,50	260,00	84,00	0,148	1		
	15303	500-560	110,00	110,00	49,00	262,00	147,00	0,541	1		
	15315	560-630	75,00	75,00	42,00	292,00	100,00	0,224	1		
	15316	560-630	90,00	90,00	45,00	292,00	120,00	0,340	1		
15318	560-630	125,00	125,00	55,00	280,00	167,00	0,792	1			
15331	630	110,00	110,00	49,00	327,00	147,00	0,563	1			

With weld-on surface and additional weld-in socket for the fusion with the inner pipe wall.
 The necessary tools for the fusion of aquatherm green pipe weld-in saddles are listed from page 160 onwards.

WELD-IN SADDLE BUTT WELDING

Material: Fusiolen® PP-R & PP-RP
 Standard: DIN 16962, DIN EN ISO 15874
 Colour: green

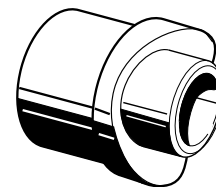
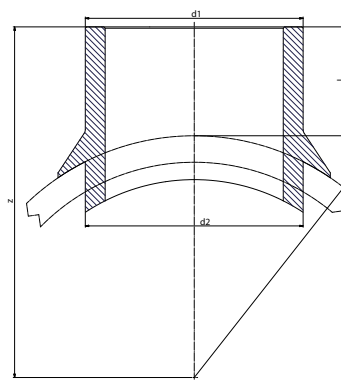

SDR	Art.-No.	d	d1	d2	l	z	Weight [kg]	PU	Box unit	Price € m/pc
butt welding										
11	15265	315	160,00	160,00	160,00	80,00	0,868	1	1	
	15271	355	160,00	160,00	160,00	80,00	0,845	1	1	

With weld-on surface and additional weld-in socket for the fusion with the inner pipe wall.
 The necessary tools for the fusion of aquatherm green pipe weld-in saddles are listed from page 160 onwards.

WELD-IN SADDLE WITH FEMALE THREAD

Material: Fusiolen® PP-R
 Standard: DIN 16962, DIN EN ISO 15874
 Colour: green
 Notice: *do not use with aquatherm blue pipe OT

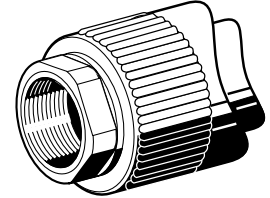
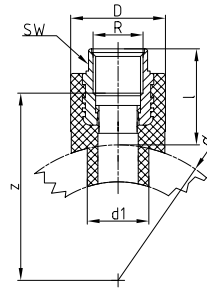

SDR	Art.-No.	d	d1	l	z	D	R	SW	Weight [kg]	PU	Box unit	Price € m/pc
socket welding												
7,4 11 17,6	28214*	40	25,00	39,00	43,00	38,50	1/2"	24,00	0,088	5	300	
	28216	50	25,00	39,00	48,00	38,50	1/2"	24,00	0,090	5	300	
	28218	63	25,00	39,00	54,50	38,50	1/2"	24,00	0,089	5	300	
	28220	75	25,00	39,00	53,50	38,50	1/2"	24,00	0,083	5	300	
	28222	90	25,00	39,00	68,00	38,50	1/2"	24,00	0,090	5	300	
	28224	110	25,00	39,00	78,00	38,50	1/2"	24,00	0,089	5	300	
	28226	125	25,00	39,00	85,50	38,50	1/2"	24,00	0,092	5	250	
	28230	160	25,00	39,00	103,00	38,50	1/2"	24,00	0,092	5	250	
	28232	200	25,00	39,00	38,00	38,50	1/2"	24,00	0,092	5	50	
	28234	40	25,00	39,00	43,00	43,50	3/4"	31,00	0,107	5	300	
	28236	50	25,00	39,00	49,50	43,50	3/4"	31,00	0,110	5	300	
	28238	63	25,00	39,00	55,50	43,50	3/4"	31,00	0,109	5	300	
	28240	75	25,00	39,00	63,00	43,50	3/4"	31,00	0,109	5	300	
	28242	90	25,00	39,00	73,00	43,50	3/4"	31,00	0,110	5	300	
	28244	110	25,00	39,00	80,50	43,50	3/4"	31,00	0,110	5	300	
	28246	125	25,00	39,00	96,00	43,50	3/4"	31,00	0,112	5	300	
	28250	160	25,00	39,00	58,50	43,50	3/4"	31,00	0,112	5	250	
	28254	200	25,00	39,00	66,00	43,50	3/4"	31,00	0,112	5	250	
	28260	75	32,00	43,00	76,00	60,00	1"	39,00	0,222	5	125	
	28262	90	32,00	43,00	83,50	60,00	1"	39,00	0,221	5	125	
28264	110	32,00	43,00	101,00	60,00	1"	39,00	0,224	5	125		
28266	125	32,00	43,00	123,00	60,00	1"	39,00	0,022	5	125		
28270	160	32,00	43,00	118,00	60,00	1"	39,00	0,226	5	125		
28274	200	32,00	43,00	121,00	60,00	1"	39,00	0,244	5	25		

WELD-IN SADDLE WITH MALE THREAD

Material: Fusiolen® PP-R
 Standard: DIN 16962, DIN EN ISO 15874
 Colour: green
 Notice: *do not use with aquatherm blue pipe OT

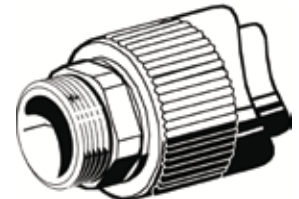
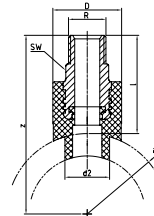

SDR	Art.-No.	d	d2	l	z	D	R	SW	Weight [kg]	PU	Box unit	Price € m/pc
socket welding												
7,4 11 17,6	28314*	40	25,00	55,00	75,00	38,50	R1/2	21,00	0,088	5	300	
	28316	50	25,00	55,00	80,00	38,50	R1/2	21,00	0,090	5	300	
	28318	63	25,00	55,00	86,50	38,50	R1/2	21,00	0,089	5	300	
	28320	75	25,00	55,00	92,50	38,50	R1/2	21,00	0,097	5	300	
	28322	90	25,00	55,00	100,00	38,50	R1/2	21,00	0,090	5	300	
	28324	110	25,00	55,00	110,00	38,50	R1/2	21,00	0,089	5	300	
	28326	125	25,00	55,00	117,50	38,50	R1/2	21,00	0,092	5	300	
	28330	160	25,00	55,00	135,00	38,50	R1/2	21,00	0,092	5	300	
	28334	40	25,00	56,00	76,00	43,50	R3/4	24,00	0,107	5	250	
	28336	50	25,00	56,00	81,00	43,50	R3/4	24,00	0,110	5	250	
	28338	63	25,00	56,00	87,50	43,50	R3/4	24,00	0,109	5	250	
	28340	75	25,00	56,00	93,50	43,50	R3/4	24,00	0,109	5	250	
	28342	90	25,00	56,00	101,00	43,50	R3/4	24,00	0,110	5	250	
	28344	110	25,00	56,00	111,00	43,50	R3/4	24,00	0,110	5	250	
	28346	125	25,00	56,00	118,50	43,50	R3/4	24,00	0,112	5	250	
	28350	160	25,00	56,00	136,00	43,50	R3/4	24,00	0,112	5	250	

With hex shaped male thread, weld-in surface and weld-in socket for fusion with the inner wall of the pipe. The necessary tools for the fusion of aquatherm green pipe weld-in saddles are listed from page 160 onwards.

FLANGE ADAPTER SOCKET WELDING

with gasket

Material: Fusiolen® PP-R
 Standard: DIN 16962, DIN EN ISO 15874
 Colour: green

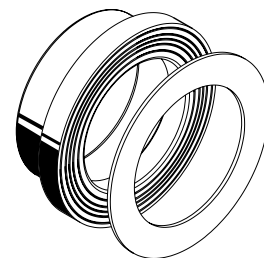
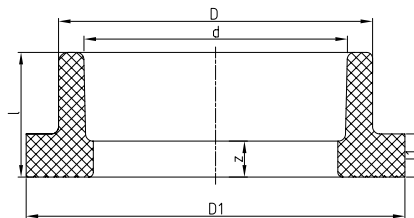

SDR	Art.-No.	Dimension d [mm]	l	z	D	D1	l1	z1	Weight [kg]	PU	Box unit	Price € m/pc
7,4 11	socket welding											
	15512	32	35,00	17,00	41,00	68,00	11,00	3,00	0,053	1	1	
	15514	40	36,50	16,00	50,00	78,00	12,00	3,00	0,071	1	1	
	15516	50	40,50	17,00	61,00	88,00	13,00	3,00	0,095	1	1	
	15518	63	44,50	16,00	76,00	102,00	15,00	3,00	0,130	1	1	
	15520	75	47,00	17,00	90,00	122,00	17,00	3,00	0,191	1	1	
	15522	90	50,00	17,00	108,00	138,00	17,00	3,00	0,258	1	1	
	15524	110	55,50	18,50	131,00	158,00	18,50	3,00	0,329	1	1	
	15526*	125	202,00	202,00	125,00	158,00	13,50	3,00	1,330	1	1	
15527	125	63,00	23,00	165,00	188,00	20,00	3,00	0,724	1	1		

*only applicable with fitting, with 110 mm flange adapter

FLANGE ADAPTER BUTT WELDING

with gasket

Material: Fusiolen® PP-R & PP-RP
 Standard: DIN 16962, DIN EN ISO 15874
 Colour: green

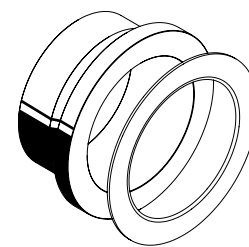
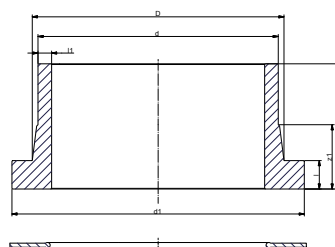

SDR	Art.-No.	Dimension d [mm]	l	z	D	D1	l1	z1	Weight [kg]	System	PU	Box unit	Price € m/pc
7,4	butt welding												
	15530	160	25,00	93,00	175,00	212,00	21,90	3,00	1,163	• •	1	1	
	15534	200	32,00	130,00	232,00	268,00	27,40	6,00	2,292	• •	1	1	
15538	250	35,00	130,00	285,00	320,00	34,20	6,00	3,298	• •	1	1		
11	butt welding												
	15531	160	25,00	93,00	175,00	212,00	14,60	6,00	0,955	• •	1	1	
	15535	200	32,00	130,00	232,00	268,00	18,20	6,00	1,957	• •	1	1	
	15539	250	35,00	130,00	285,00	320,00	22,70	6,00	2,717	• •	1	1	
	15543	315	35,00	170,00	333,00	370,00	28,60	6,00	5,650	• •	1	1	
	15545	355	42,00	185,00	370,00	432,00	32,20	6,00	9,000	• •	1	1	
	15547	400	33,00	199,00	425,00	484,00	22,70	6,00		• •	1	1	
15549	450	46,00	140,00	425,00	586,00	25,70	7,00		• •	1	1		
17,6	2515530	160	25,00	93,00	175,00	212,00	9,10	3,00	0,821	•	1	11	
	2515534	200	32,00	130,00	232,00	268,00	11,40	6,00		•	1	11	
	2515538	250	35,00	130,00	285,00	320,00	14,20	6,00	2,736	•	1	11	
	2515542	315	35,00	170,00	333,00	370,00	17,90	6,00	4,500	•	1	11	
	2515544	355	42,00	185,00	370,00	432,00	20,10	6,00	6,500	•	1	11	
	2515546	400	33,00	199,00	425,00	484,00	22,70	6,00	8,500	•	1	11	
	2515548	450	46,00	140,00	512,00	586,00	25,70	7,00	12,000	•	1	11	
	2515550	500	47,00	141,00	525,00	585,00	28,40	7,00	9,800	•	1	11	
	2515552	560	50,00	141,00	612,00	685,00	31,70	7,00	13,800	•	1	11	
2515554	630	50,00	142,00	640,00	688,00	35,70	7,00	12,600	•	1	11		

PLASTIC COATED STEEL FLANGE

Material: PP/steel

Colour: grey

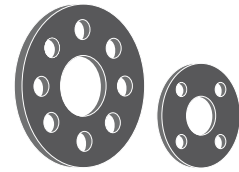
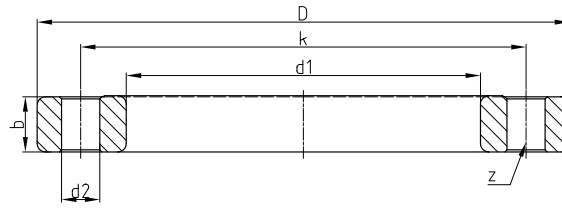

SDR	Art.-No.	Dimension	fits to Art.-No.	d1	D	K	d2	b	z	Weight [kg]	PU	Box unit	Price € m/pc
socket welding													
7,4 11 17,6	15712	32	15512	42,00	116,00	85,00	14,00	15,50	4,00	0,466	1	1	
	15714	40	15514	51,00	141,00	100,00	18,00	17,50	4,00	0,681	1	1	
	15716	50	15516	62,00	151,00	110,00	18,00	17,50	4,00	0,767	1	1	
	15718	63	15518	78,00	166,00	125,00	18,00	19,00	4,00	0,885	1	1	
	15720	75	15520	92,00	186,00	145,00	18,00	19,00	4,00	1,154	1	1	
	15722	90	15522	110,00	201,00	160,00	18,00	21,00	8,00	1,404	1	1	
	15724	110	15524/26	133,00	221,00	180,00	18,00	22,00	8,00	1,461	1	1	
	15726	125	15527	167,00	251,00	210,00	18,00	26,00	8,00	2,096	1	1	
	15730	160	15530 15531 2515530	178,00	286,00	240,00	22,00	27,00	8,00	3,628	1	1	
	15734	200	15534 15535 2515534	235,00	341,00	295,00	22,00	28,00	8,00	4,643	1	1	
	15738	250	15538 15539 2515538	288,00	406,00	350,00	22,00	31,00	12,00	7,216	1	1	
	15742	315	15543 2515542	340,00	460,00	400,00	22,00	34,50	12,00	9,500	1	1	
	15744	355	15545 2515544	380,00	520,00	460,00	22,00	39,00	16,00	15,300	1	1	
	15746	400	2515546	430,00	565,00	515,00	26,00	34,00	16,00	50,558	1	1	
	15748	450	2515548	517,00	670,00	620,00	26,00	42,00	20,00	65,789	1	1	
15750	500	2515550	533,00	670,00	620,00	26,00	38,00	20,00	60,783	1	1		
15752	560	2515552	618,00	785,00	725,00	30,00	50,00	20,00	95,096	1	1		
15754	630	2515554	645,00	785,00	725,00	30,00	40,00	20,00	82,112	1	1		

COUPLING SCREW JOINT

Material: Fusiolen® PP-R, brass

Standard: DIN 16962, DIN EN ISO 15874

Colour: green, brassy

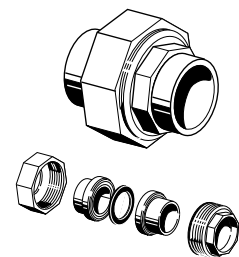
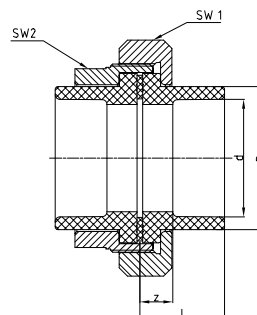

SDR	Art.-No.	Dimension d [mm]	l	z	D	SW1	SW2	Weight [kg]	PU	Box unit	Price € m/pc
socket welding											
7,4 11	15812	32	36,50	18,50	41,00	64,00	50,00	0,479	1		
	15814	40	38,00	17,50	50,00	80,00	60,00	0,841	1		
	15816	50	41,00	17,50	61,00	86,00	70,00	0,821	1		
	15818	63	45,00	17,50	76,00	108,00	90,00	1,498	1		
	15820	75	47,50	17,50	90,00	128,00	104,00	1,998	1		

COUPLING SCREW JOINT

Material: Fusiolen® PP-R
 Standard: DIN 16962, DIN EN ISO 15874
 Colour: green

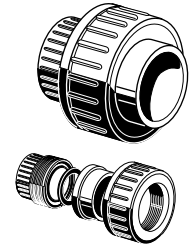
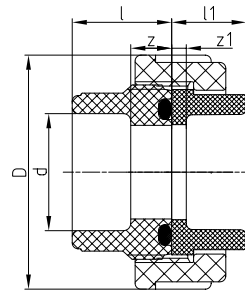

SDR	Art.-No.	Dimension d [mm]	l	z	l1	z1	D	Weight [kg]	PU	Box unit	Price € m/pc
socket welding											
7,4 11	15838	20	26,00	12,00	20,00	5,50	46,00	0,036	10	300	
	15840	25	28,00	12,00	21,00	5,00	56,00	0,058	10	250	
	15842	32	32,00	12,00	23,00	5,00	66,00	0,089	5	200	
	15844	40	38,00	14,00	25,50	5,00	79,00	0,136	5	150	
	15846	50	45,00	16,00	28,50	5,00	87,00	0,170	5	100	
	15848	63	55,50	20,00	32,50	5,00	107,00	0,240	1	60	
	15850	75	50,00	20,00	36,00	6,00	50,00	0,451	1	1	

ELECTROFUSION SOCKET

Material: Fusiolen® PP-R
 Standard: DIN 16962, DIN EN ISO 15874
 Colour: green
 Notice: do not use with 160 mm fittings
 *do not use with aquatherm blue pipe OT pipe

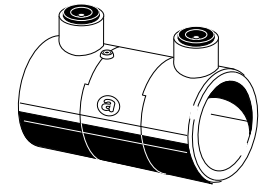
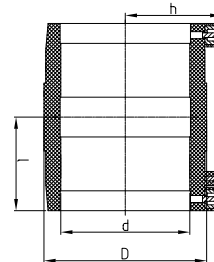

SDR	Art.-No.	Dimension d [mm]	l	l1	D	Weight [kg]	PU	Box unit	Price € m/pc
Electro-socket welding									
7,4 11 17,6	17208	20	35,00	36,00	31,50	0,049	1	500	
	17210	25	39,00	38,50	36,50	0,057	1	350	
	17212	32	40,00	42,50	45,00	0,077	1	300	
	17214	40	46,00	47,00	54,00	0,103	1	200	
	17216	50	51,50	52,00	65,00	0,142	1	130	
	17218	63	59,00	58,00	81,50	0,239	1	75	
	17220	75	65,00	64,50	96,00	0,347	1	45	
	17222	90	72,50	72,00	113,50	0,501	1	30	
	17224	110	80,00	82,50	139,00	0,821	1	22	
	17226	125	86,00	90,00	156,00	1,097	1	16	
	17230*	160	93,00	109,50	197,00	1,754	1	10	
	17234*	200	105,00	134,00	243,00	3,625	1		
17238*	250	125,00	170,00	315,00	7,142	1			

BACK PLATE ELBOW

Material: Fusiolen® PP-R, brass
 Standard: DIN 16962, DIN EN ISO 15874
 Colour: green

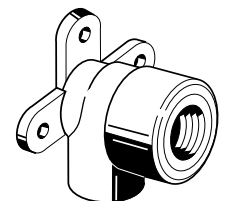
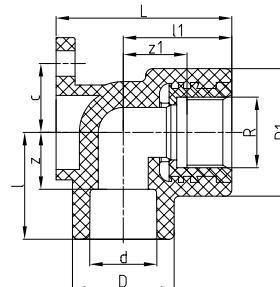

SDR	Art.-No.	d	R	l	z	D	l1	z1	D1	L	c	Weight [kg]	PU	Box unit	Price € m/pc
socket welding															
7,4 11	20108	20	1/2"	31,00	16,50	29,50	31,50	15,50	37,00	51,00	20,00	0,079	10	200	
	20110	20	3/4"	37,00	22,50	34,00	37,00	24,00	44,00	54,00	25,00	0,102	10	150	
	20112	25	3/4"	37,00	21,00	34,00	37,00	24,00	44,00	54,00	25,00	0,105	10	150	
	20113	25	1/2"	33,50	17,50	34,00	31,00	15,00	37,00	53,00	20,00	0,081	10	200	

MOUNTING PLATE

galvanized; to fix back plate elbows as double connection

Material: iron, galvanized

Colour: zinc

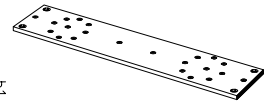
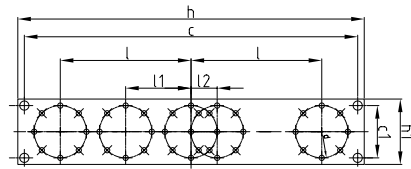

Art.-No.	d	l	l1	l2	c	c1	h	h1	Weight [kg]	PU	Box unit	Price € m/pc
60010	40	100,00	50,00	20,00	255,00	40,00	265,00	50,00	0,221	1	1	

not suitable for connection with sound insulation plate (Art.-No. 79080).
We recommend mounting rail Art.-No. 79090.

MOUNTING PLATE

galvanized; to fix back plate elbows as double connection including 2 fixing plates and 4 screws

Material: iron, galvanized

Colour: zinc

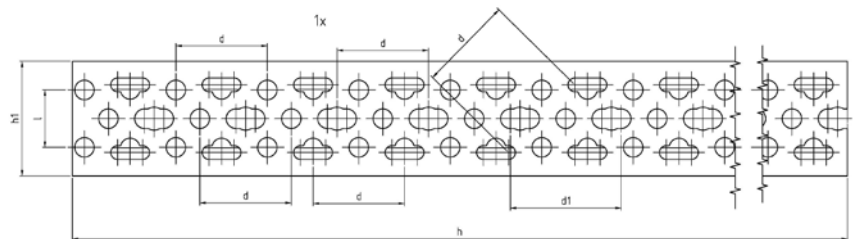
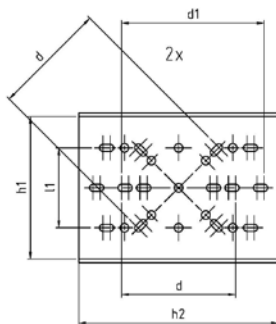

Art.-No.	d	d1	l	l1	h	h1	h2	Weight [kg]	PU	Box unit	Price € m/pc
79090	40	50,00	25,00	28,00	560,00	50,00	70,00	0,546	2	4	

SOUND ISOLATION PLATE

for aquatherm green pipe-and aquatherm grey pipe-back plate elbow

Material: PP

Colour: white

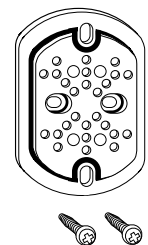
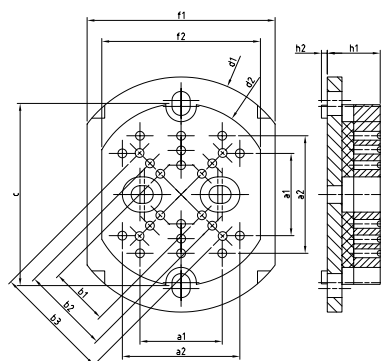

Art.-No.	a1	a2	b1	b2	b3	c	d1	d2	f1	f2	h1	h2	Weight [kg]	PU	Box unit	Price € m/pc
79080	28,00	40,00	20,00	30,00	40,00	62,00	80,00	62,00	64,00	54,00	18,00	2,00	0,058	2		

MOUNTING RAIL (DOUBLE AND SINGLE)

Material: iron, galvanized
Colour: zinc

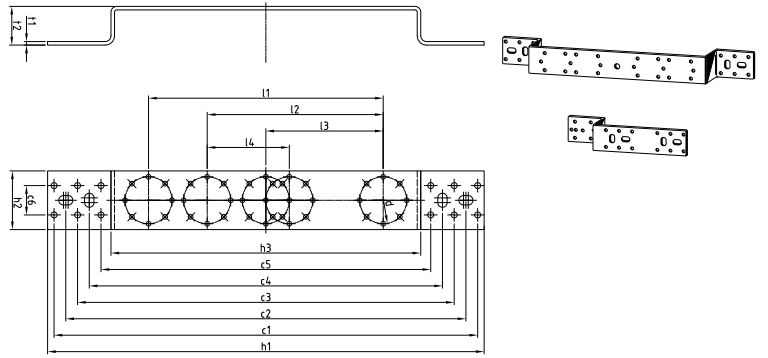

Art.-No.	d	l1	l2	l3	l4	c1	c2	c3	c4	c5	c6	h1	h2	h3	t1	t2	Weight [kg]	PU	Box unit	Price € m/pc
79095	40	200,00	150,00	100,00	70,00	361,00	341,00	321,00	301,00	281,00	25,00	372,00	50,00	264,00	3,00	33,00	0,412	2	4	
79096																	0,235	2	4	

DRY CONSTRUCTION WALL FITTING

Material: brass

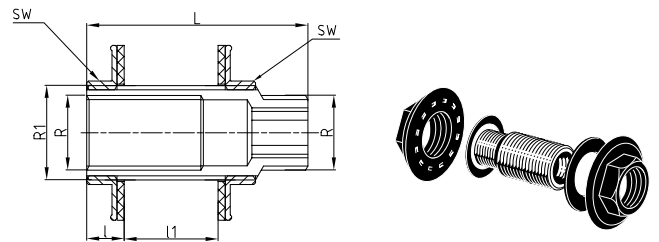

Art.-No.	R	R1	l	l1	L	SW	Weight [kg]	PU	Box unit	Price € m/pc
20114	1/2"	3/4"	10,50	26,00	62,00	30,00	0,213	10	300	

BACK PLATE ELBOW FOR DRY CONSTRUCTION

Material: Fusiolen® PP-R, brass
Standard: DIN 16962, DIN EN ISO 15874
Colour: green

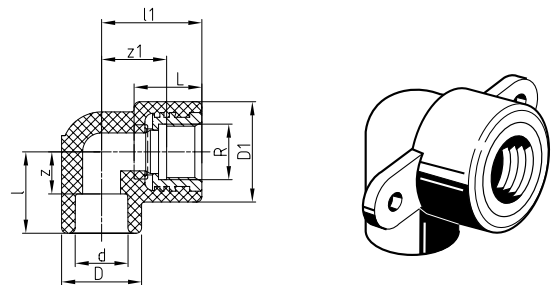

SDR	Art.-No.	d	R	l	z	D	l1	z1	D1	L	c	Weight [kg]	PU	Box unit	Price € m/pc
7,4 11	socket welding														
	20156	16	1/2"	30,00	17,00	29,50	37,00	24,00	37,00	25,00	59,00	0,079	10	250	
	20158	20	1/2"	30,00	15,50	29,50	37,00	24,00	37,00	25,00	59,00	0,079	10	200	

TRANSITION PIECE

with counternut, gasket and tension washer

Material: Fusiolen® PP-R, brass
Standard: DIN 16962, DIN EN ISO 15874
Colour: green

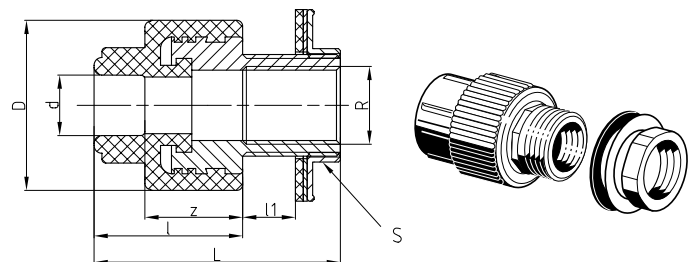

SDR	Art.-No.	d	R	l	z	D	l1	L	SW	Weight [kg]	PU	Box unit	Price € m/pc
7,4 11	socket welding												
	20204	20	1/2"	40,00	25,50	43,50	13,50	65,00	29,00	0,204	10	1	

e.g. for connection of a cistern or application with mounting plate (Art.-No. 60110-60115)

TRANSITION ELBOW

with counternut, gasket and tension washer

Material: Fusiolen® PP-R, brass
 Standard: DIN 16962, DIN EN ISO 15874
 Colour: green

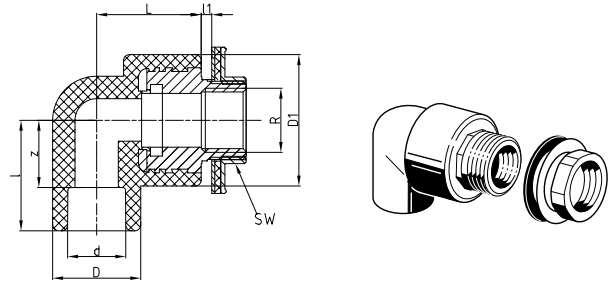

SDR	Art.-No.	d	R	l	z	D	l1	L	D1	SW	Weight [kg]	PU	Box unit	Price € m/pc
7,4 11	socket welding													
	20206	16	1/2"	37,00	24,00	29,50	3,50	35,00	44,00	29,00	0,201	10		
	20208	20	1/2"	37,00	22,50	29,50	3,50	35,00	44,00	29,00	0,154	10		
	20209	25	1/2"	37,00	21,00	34,00	3,50	37,00	44,00	29,00	0,206	10		

e.g. for connection of a cistern or application with mounting plate (Art.-No. 60110-60115)

ASSEMBLING JIG

as water level with 2 plugs 1/2"

Material: Fusiolen® PP-R
 Colour: green

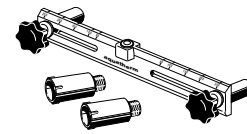

Art.-No.	a	b	h1	l1	l2	d	l	R	Weight [kg]	PU	Box unit	Price € m/pc
50700	280,00	36,00	8,00	80,00	250,00	28	55,50	1/2"	0,252	1		

PLUG FOR PRESSURE TESTS

with gasket

Material: Fusiolen® PP-R
 Standard: DIN 16962, DIN EN ISO 15874
 Colour: green

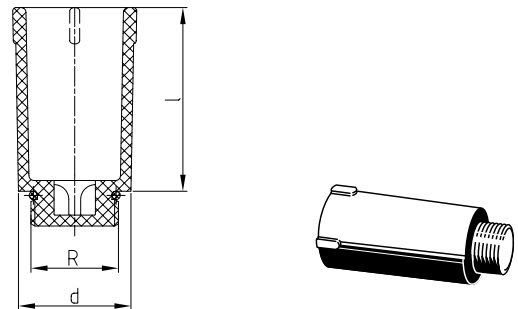

Art.-No.	d	R	l	Weight [kg]	PU	Box unit	Price € m/pc
50708	28	1/2"	55,50	0,022	10		
50710	34	3/4"	55,50	0,027	10		

MOUNTING UNIT

double

Material: iron/galvanized
 Colour: zinc

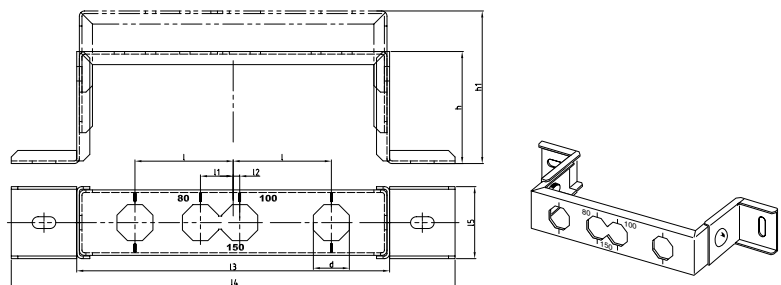

Art.-No.	b	l	l1	l2	h	h1	l3	l4	l5	Weight [kg]	PU	Box unit	Price € m/pc
60110	27,50	75,00	25,00	5,00	92,50	122,50	239,00	339,00	55,00	0,630	1	1	

MOUNTING UNIT

single

Material: iron/galvanized

Colour: zinc

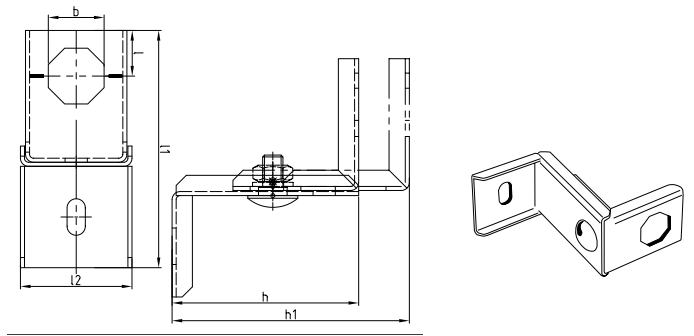

Art.-No.	b	l	l1	l2	h	h1	Weight [kg]	PU	Box unit	Price € m/pc
60115	27,50	118,00	22,50	55,00	92,50	122,50	0,278	1	1	

MOUNTING UNIT

with two aquatherm green pipe transition elbows (Art.-No. 20208), with counternut, gasket and tension washer

Material: Fusiolen® PP-R, brass
iron/galvanized

Colour: green
zinc

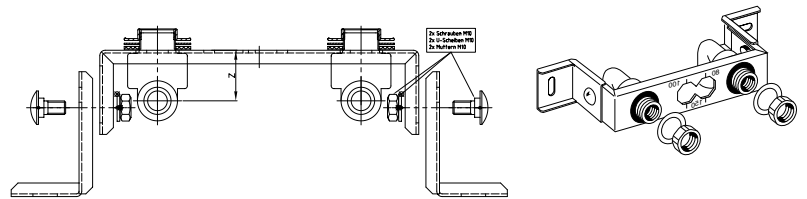

Art.-No.	b	l	l1	l2	h	h1	l3	l4	l5	Weight [kg]	PU	Box unit	Price € m/pc
60150	27,50	75,00	25,00	5,00	92,50	122,50	239,00	339,00	55,00	0,942	1	1	

MOUNTING UNIT

with one aquatherm green pipe transition elbow (Art.-No. 20208), with counternut, gasket and tension washer

Material: Fusiolen® PP-R, brass
iron/galvanized

Colour: green
zinc

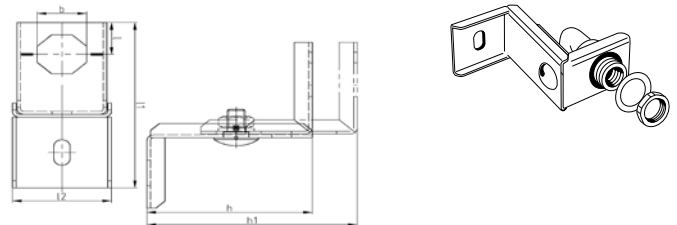

Art.-No.	b	l	l1	l2	h	h1	Weight [kg]	PU	Box unit	Price € m/pc
60155	27,5	22,5	118	55	92,5	122,5	0,278	1	1	

TRANSITION ELBOW

for plasterboard

Material: Fusiolen® PP-R, brass

Colour: green

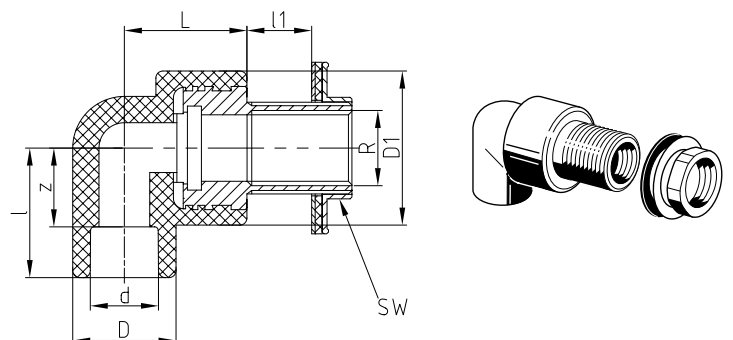

SDR	Art.-No.	d	R	l	z	D	L	l1	D1	SW	Weight [kg]	PU	Box unit	Price € m/pc
7,4	20210	20	1/2"	37,00	22,50	29,50	35,00	18,50	44,00	29,00	0,223	10		
11														

with 30 mm thread, counternut, gasket and tension washer

TRANSITION PIECE WITH FEMALE THREAD

round

Material: Fusiolen® PP-R, brass

Standard: DIN 16962, DIN EN ISO 15874

Colour: green

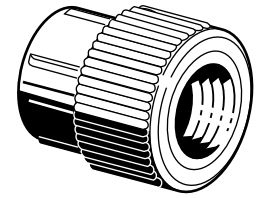
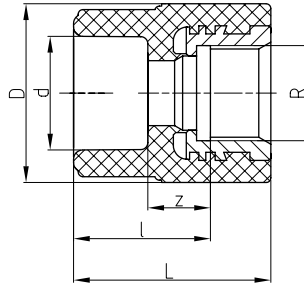

SDR	Art.-No.	d	R	l	z	D	L	Weight [kg]	PU	Box unit	Price € m/pc
7,4 11	21008	20	1/2"	27,50	13,00	37,50	40,50	0,064	10	400	
	21010	20	3/4"	27,50	13,00	43,50	40,50	0,089	10	300	
	21011	25	1/2"	29,00	13,00	37,50	42,00	0,065	10	400	
	21012	25	3/4"	27,50	11,50	43,50	40,50	0,087	10	300	
	21013	32	3/4"	30,50	12,50	43,50	43,50	0,092	5	200	

TRANSITION PIECE WITH FEMALE THREAD

hex shaped threaded transition

Material: Fusiolen® PP-R, brass

Standard: DIN 16962, DIN EN ISO 15874

Colour: green

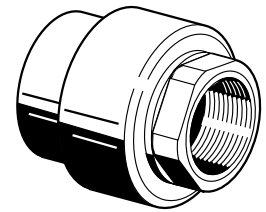
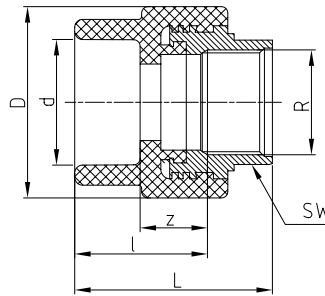

SDR	Art.-No.	d	R	l	z	D	L	SW	Weight [kg]	PU	Box unit	Price € m/pc
7,4 11	21108	20	1/2"	34,50	20,00	37,50	50,50	24,00	0,088	10	400	
	21110	20	3/4"	29,00	14,50	43,50	50,00	31,00	0,112	10	300	
	21111	25	1/2"	36,00	20,00	37,50	52,00	24,00	0,089	10	300	
	21112	25	3/4"	29,00	13,00	43,50	50,00	31,00	0,109	10	300	
	21113	32	3/4"	32,00	14,00	43,50	53,00	31,00	0,114	5	150	
	21114	32	1"	37,50	19,50	60,00	59,50	39,00	0,239	5	125	
	21115	40	1"	40,00	19,50	60,00	62,00	39,00	0,245	5	125	
	21116	40	1 1/4"	40,00	19,50	74,00	63,00	50,00	0,385	5	80	
	21117	50	1 1/4"	43,00	19,50	74,00	66,00	50,00	0,404	5	75	
	21118	50	1 1/2"	45,00	21,50	85,50	67,00	55,00	0,424	5	60	
	21119	63	1 1/2"	51,50	24,00	84,00	73,50	55,00	0,440	1	50	
	21120	63	2"	50,00	22,50	101,00	76,00	67,00	0,589	1	35	
21122	75	2"	51,00	21,00	100,00	77,00	67,00	0,613	1	25		

TRANSITION PIECE WITH MALE THREAD

round, self sealing

Material: Fusiolen® PP-R, brass

Standard: DIN 16962, DIN EN ISO 15874

Colour: green

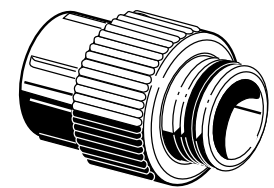
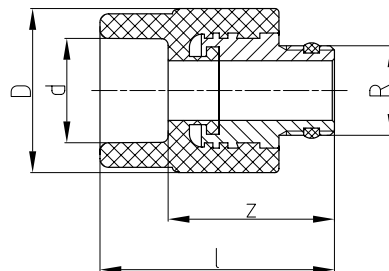

SDR	Art.-No.	d	R	l	z	D	Weight [kg]	PU	Box unit	Price € m/pc
7,4 11	21258	20	1/2"	52,50	38,00	38,50	0,090	10		
	21261	25	1/2"	54,00	38,00	38,50	0,091	10		
	21262	25	3/4"	53,50	37,50	38,50	0,098	10		

TRANSITION PIECE WITH MALE THREAD

round

Material: Fusiolen® PP-R, brass

Standard: DIN 16962, DIN EN ISO 15874

Colour: green

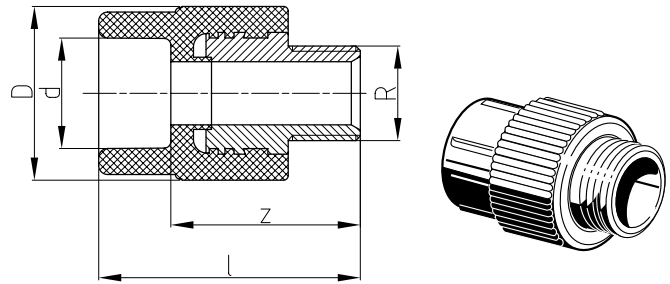

SDR	Art.-No.	d	R	l	z	D	Weight [kg]	PU	Box unit	Price € m/pc
7,4 11	21208	20	1/2"	56,50	42,00	38,50	0,097	10	400	
	21210	20	3/4"	57,50	43,00	38,50	0,109	10	300	
	21211	25	1/2"	58,00	42,00	38,50	0,098	10	300	
	21212	25	3/4"	57,50	41,50	38,50	0,107	10	350	
	21213	32	3/4"	59,50	41,50	43,00	0,115	5	250	

TRANSITION PIECE WITH MALE THREAD

with hex shaped threaded transition

Material: Fusiolen® PP-R, brass

Standard: DIN 16962, DIN EN ISO 15874

Colour: green

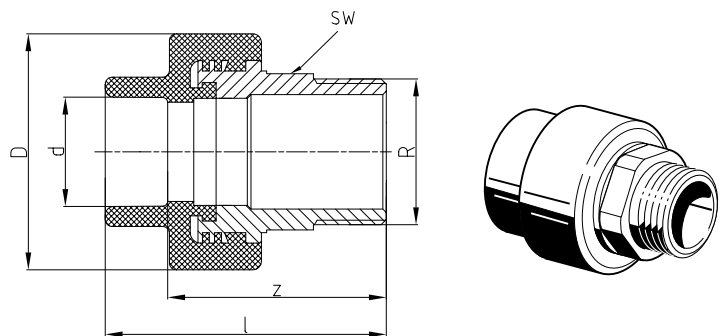

SDR	Art.-No.	d	R	l	z	D	Weight [kg]	PU	Box unit	Price € m/pc
7,4 11	21308	20	1/2"	66,50	52,00	38,50	0,104	10	300	
	21310	20	3/4"	67,50	53,00	38,50	0,129	10	300	
	21312	25	3/4"	67,50	51,50	38,50	0,103	10	300	
	21314	32	1"	78,50	60,50	53,00	0,216	5	125	
	21316	32	1 1/4"	81,00	63,00	68,00	0,320	5	100	
	21317	40	1"	81,00	60,50	52,00	0,222	5	100	
	21318	40	1 1/4"	84,50	64,00	68,00	0,326	5	80	
	21319	50	1 1/4"	85,50	62,00	68,00	0,352	5	75	
	21320	50	1 1/2"	88,50	65,00	74,00	0,429	5	60	
	21321	63	1 1/2"	94,50	67,00	72,50	0,466	1	40	
	21322	63	2"	102,50	75,00	84,00	0,679	1	40	
	21323	75	2"	102,00	72,00	84,00	0,729	1	25	
	21324	75	2 1/2"	105,00	75,00	100,00	0,972	1	25	
	21325	90	3"	121,00	88,00	120,00	1,315	1	20	
	21327	110	4"	148,00	111,00	147,00	2,699	1	8	

Notice: aquatherm green and blue pipe-metal compound fittings are manufactured from fusiolen PP-R and brass. Metal inserts, without hex shaped spanner flat, with 1/2" and 3/4" f are also available in stainless steel. aquatherm green pipe stainless steel price list Order-. No.: E53180 on request!!

TRANSITION PIECE WITH MALE THREAD

self-sealing, with hex shaped threaded transition male/male

Material: Fusiolen® PP-R, brass
 Standard: DIN 16962, DIN EN ISO 15874
 Colour: green

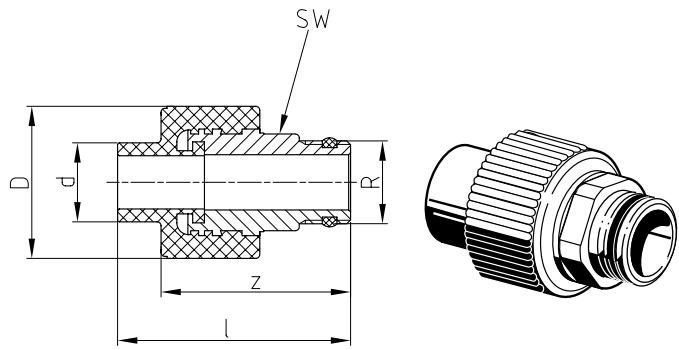

SDR	Art.-No.	d	R	l	z	D	Weight [kg]	PU	Box unit	Price € m/pc
7,4 11	21355	20	1/2"	59,00	48,00	38,50	0,107	10		

TRANSITION PIECE WITH MALE THREAD

self-sealing, with hex shaped threaded transition female/male

Material: Fusiolen® PP-R, brass
 Standard: DIN 16962, DIN EN ISO 15874
 Colour: green

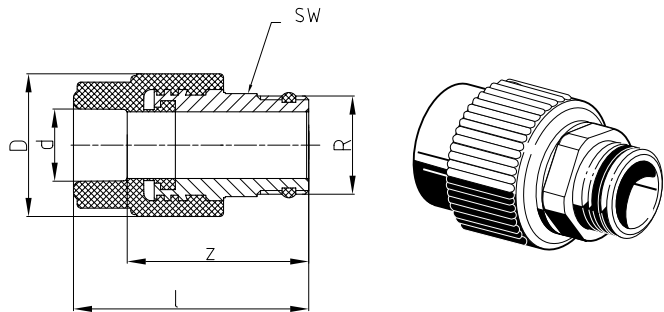

SDR	Art.-No.	d	R	l	z	D	Weight [kg]	PU	Box unit	Price € m/pc
7,4 11	21358	20	1/2"	63,50	49,00	38,50	0,111	10		

TRANSITION ELBOW WITH FEMALE THREAD

Material: Fusiolen® PP-R, brass
 Standard: DIN 16962, DIN EN ISO 15874
 Colour: green

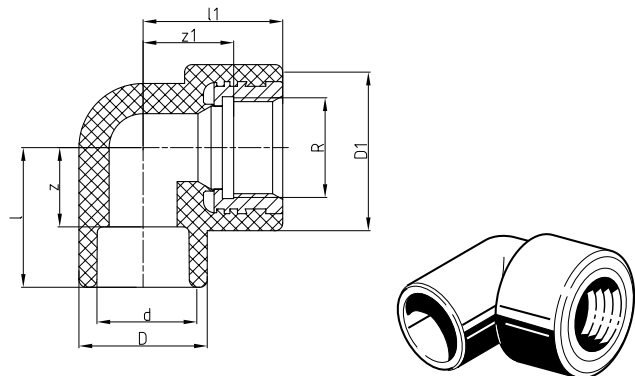

SDR	Art.-No.	d	R	l	z	D	l1	z1	D1	Weight [kg]	PU	Box unit	Price € m/pc
7,4 11	23008	20	3/4"	37,00	22,50	34,00	37,00	24,00	44,00	0,102	10	250	
	23010	20	1/2"	31,50	17,00	29,50	31,50	18,50	37,00	0,074	10	300	
	23012	25	3/4"	37,00	21,00	34,00	37,00	24,00	44,00	0,100	10	200	
	23014	25	1/2"	34,00	18,00	34,00	37,00	24,00	37,00	0,074	10	250	
	23016	32	3/4"	27,50	9,50	43,00	51,00	38,00	44,00	0,104	5	150	
	23018	32	1"	34,00	16,00	43,00	66,50	44,50	60,50	0,251	5	100	

Notice: aquatherm green and blue pipe-metal compound fittings are manufactured from fusiolen PP-R and brass. Metal inserts, without hex shaped spanner flat, with 1/2" and 3/4" f are also available in stainless steel. aquatherm green pipe stainless steel price list Order-. No.: E53180 on request!!

TRANSITION ELBOW WITH FEMALE THREAD

Material: Fusiolen® PP-R, brass
 Standard: DIN 16962, DIN EN ISO 15874
 Colour: green

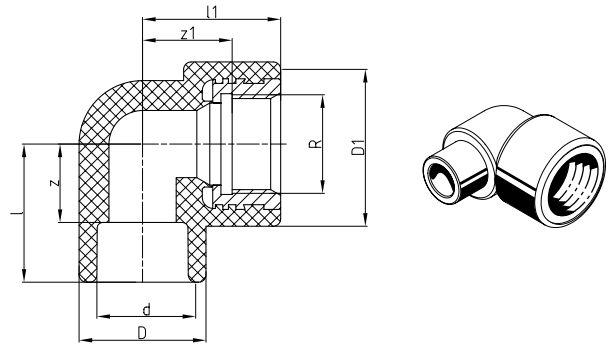

SDR	Art.-No.	d	R	l	z	D	l1	z1	D1	Weight [kg]	PU	Box unit	Price € m/pc
7,4 11													
	23208	20	1/2"	33,50	18,50	29,50	37,00	24,00	37,00	0,076	10	300	

TRANSITION ELBOW WITH MALE THREAD

Material: Fusiolen® PP-R, brass
 Standard: DIN 16962, DIN EN ISO 15874
 Colour: green

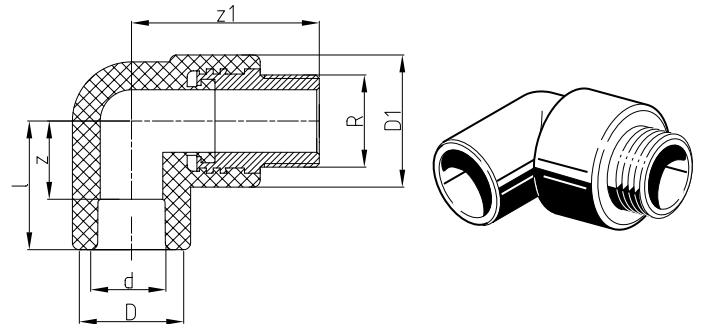

SDR	Art.-No.	d	R	l	z	D	z1	D1	Weight [kg]	PU	Box unit	Price € m/pc
7,4 11												
	23506	20	1/2"	31,50	17,00	29,50	53,00	37,00	0,108	10	300	
	23508	20	3/4"	37,00	22,50	34,00	54,00	38,00	0,128	10	200	
	23510	25	3/4"	37,00	21,00	34,00	54,00	38,00	0,105	10	250	
	23512	32	3/4"	27,50	9,50	43,00	68,00	38,00	0,112	5	150	
23514	32	1"	31,00	13,00	43,00	85,50	52,00	0,233	5	100		

THREADED BRANCH TEE WITH FEMALE THREAD

Material: Fusiolen® PP-R, brass
 Standard: DIN 16962, DIN EN ISO 15874
 Colour: green

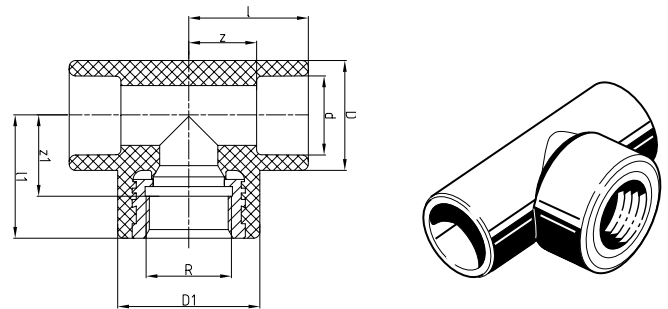

SDR	Art.-No.	d	R	l	z	D	l1	z1	D1	Weight [kg]	PU	Box unit	Price € m/pc
7,4 11													
	25006	20	1/2"	31,50	17,00	29,50	37,00	24,00	37,00	0,086	10	250	
	25008	20	3/4"	37,00	22,50	34,00	38,00	25,00	44,00	0,121	10	170	
	25010	25	1/2"	34,00	18,00	34,00	38,00	25,00	37,00	0,091	10	200	
	25012	25	3/4"	37,00	21,00	34,00	38,00	25,00	44,00	0,109	10	150	
	25013	32	1/2"	35,00	17,00	37,00	37,00	24,00	37,00	0,103	5		
	25014	32	3/4"	27,50	9,50	43,00	51,00	38,00	44,00	0,111	5	100	
	25016	32	1"	31,00	13,50	43,00	67,00	49,00	60,00	0,254	5	80	
	25018	40	1/2"	42,50	22,00	52,00	39,00	26,00	37,00	0,180	5		
	25019	40	3/4"								5		
	25020	40	1"	41,50	21,00	52,00	56,00	34,00	60,00	0,329	5		
25022	50	1"	49,50	26,00	68,00	63,50	43,50	68,00	0,385	5	40		

Notice: aquatherm green and blue pipe-metal compound fittings are manufactured from fusiolen PP-R and brass. Metal inserts, without hex shaped spanner flat, with 1/2" and 3/4" f are also available in stainless steel. aquatherm green pipe stainless steel price list Order- No.: E53180 on request!!

THREADED BRANCH TEE WITH MALE THREAD

Material: Fusiolen® PP-R, brass
 Standard: DIN 16962, DIN EN ISO 15874
 Colour: green

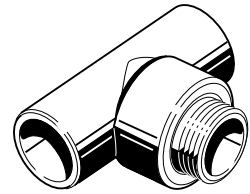
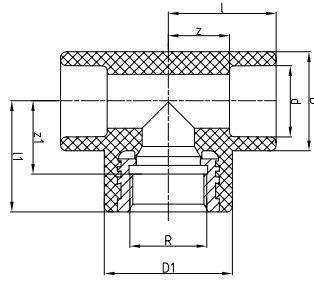

SDR	Art.-No.	d	R	l	z	D	z1	D1	Weight [kg]	PU	Box unit	Price € m/pc
7,4 11	25506	20	1/2"	31,50	17,00	29,50	53,00	37,00	0,102	10	200	

TRANSITION COUPLING WITH MALE THREAD

with union nut and welding socket

Material: Fusiolen® PP-R, brass
 Standard: DIN 16962, DIN EN ISO 15874
 Colour: green

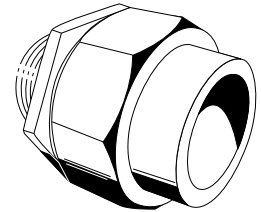
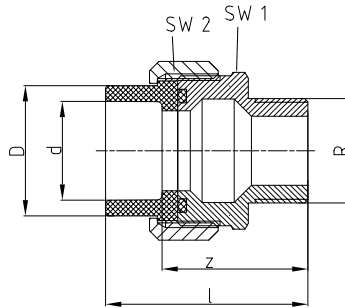

SDR	Art.-No.	d	R	l	z	D	SW1	SW2	Weight [kg]	PU	Box unit	Price € m/pc
7,4 11	26608	20	1/2"	54,50	40,00	27,50	36,00	36,00	0,145	1		
	26610	25	3/4"	59,50	43,50	36,00	46,00	46,00	0,243	1		
	26612	32	1"	64,50	46,50	41,50	52,00	50,00	0,336	1		
	26614	40	1 1/4"	70,00	49,50	53,00	64,00	65,00	0,632	1		
	26616	50	1 1/2"	86,50	63,00	59,00	72,00	57,00	0,624	1		
	26618	63	2"	95,50	68,00	74,00	89,00	66,00	1,212	1		

TRANSITION COUPLING WITH FEMALE THREAD

with union nut and welding socket

Material: Fusiolen® PP-R, brass
 Standard: DIN 16962, DIN EN ISO 15874
 Colour: green

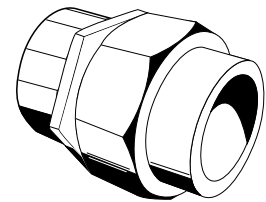
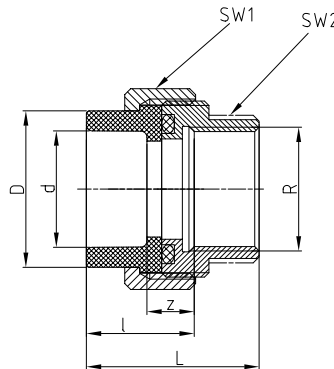

SDR	Art.-No.	d	R	l	z	D	L	SW1	SW2	Weight [kg]	PU	Box unit	Price € m/pc
7,4 11	26638	20	1/2"	30,00	15,50	27,50	45,00	36,00	25,00	0,083	1		
	26640	25	3/4"	32,00	16,00	36,00	49,00	45,00	32,00	0,193	1		
	26642	32	1"	37,00	19,00	41,50	54,00	52,00	40,00	0,291	1		
	26644	40	1 1/4"	36,50	16,00	53,00	58,50	64,00	47,00	0,423	1		
	26646	50	1 1/2"	45,50	22,00	59,00	64,50	72,00	57,00	0,610	1		
	26648	63	2"	50,50	23,00	74,00	74,50	89,00	68,00	0,924	1		

Notice: aquatherm green and blue pipe-metal compound fittings are manufactured from fusiolen PP-R and brass. Metal inserts, without hex shaped spanner flat, with 1/2" and 3/4" f are also available in stainless steel. aquatherm green pipe stainless steel price list Order-. No.: E53180 on request!!

LOOSE NUT ADAPTER

length: 100 mm, with gasket

Material: Fusiolen® PP-R, brass
 Standard: DIN 16962, DIN EN ISO 15874
 Colour: green

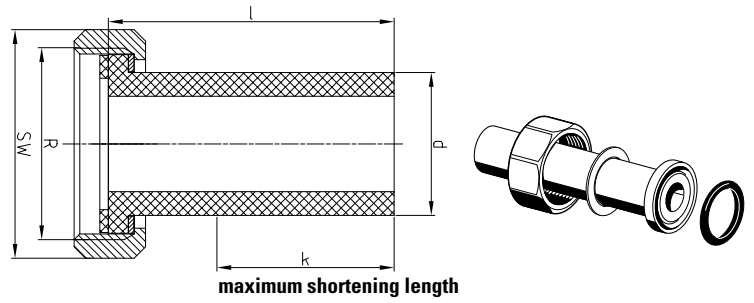

SDR	Art.-No.	d	Nut R	l	k	SW	Weight [kg]	PU	Box unit	Price € m/pc
7,4 11	26708	20	1"	100,00	65,00	36,00	0,079	1	150	
	26710	25	1 1/4"	100,00	62,00	46,00	0,104	1	125	
	26712	32	1 1/2"	100,00	58,00	52,00	0,175	1	100	
	26714	40	2"	100,00	53,00	64,00	0,258	1	75	
	26716	50	2 1/4"	100,00	49,00	72,00	0,344	1	60	
	26718	63	2 3/4"	100,00	43,00	89,00	0,583	1	40	
	26720	75	3 1/2"	100,00	34,00	110,00	0,918	1	30	
	26722	90	4"	100,00	26,00	120,00	1,238	1	20	

WATER METER NUT ADAPTER

with gasket

Material: Fusiolen® PP-R, brass
 Standard: DIN 16962, DIN EN ISO 15874
 Colour: green

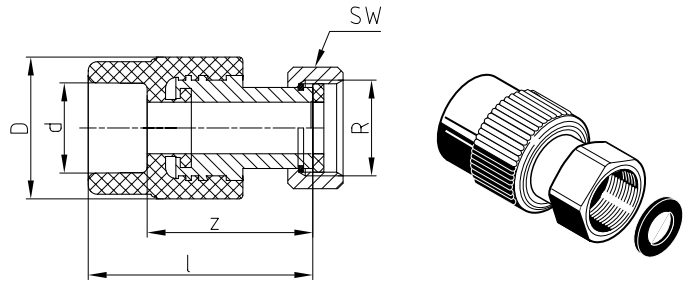

SDR	Art.-No.	d	Nut R	l	z	D	SW	Weight [kg]	PU	Box unit	Price € m/pc
7,4 11	26808	20	3/4"	59,50	45,00	38,50	30,00	0,153	1		
	26810	25	3/4"	61,00	45,00	38,50	30,00	0,155	1		
	26812	32	3/4"	62,00	44,00	43,50	30,00	0,162	1		

NUT ADAPTER

ISO-standard

Material: Fusiolen® PP-R, brass
 Standard: DIN 16962, DIN EN ISO 15874
 Colour: green

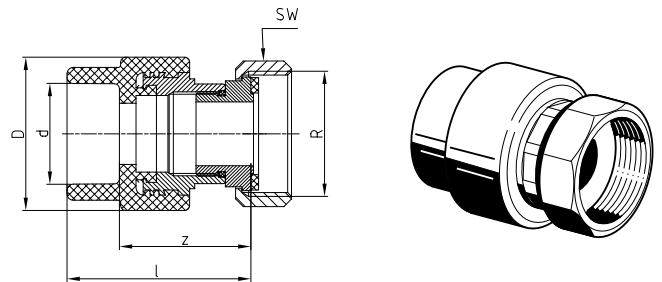

SDR	Art.-No.	d	Nut R	L	z	D	SW	Weight [kg]	PU	Box unit	Price € m/pc
7,4 11	27010	20	1"	58,50	36,00	38,50	36,00	0,182	10		
	27011	25	1"	60,00	44,00	38,50	36,00	0,186	10		
	27012	25	1 1/4"	60,00	44,00	43,50	46,00	0,274	10		
	27013	32	1 1/4"	63,00	45,00	43,50	46,00	0,279	5		
	27014	32	1 1/2"	69,50	51,50	60,00	52,00	0,446	5		
	27015	40	1 1/2"	72,00	51,50	60,00	52,00	0,421	5		
	27016	40	2"	74,00	53,50	74,00	64,00	0,719	5		
	27017	50	2"	77,00	53,50	74,00	64,00	0,736	5		
	27018	50	2 1/4"	77,00	54,50	84,00	72,00	0,831	5		
	27019	63	2 1/4"	83,50	56,00	84,00	72,00	0,889	1		
	27020	63	2 3/4"	84,00	56,50	101,00	89,00	1,306	1		
	27021	75	2 3/4"	85,00	55,00	100,00	89,00	1,275	1		
	27022	75	3 1/2"	91,00	61,00	100,00	110,00	1,818	1		

COUNTERPART

with welding socket and male thread for ISO-standard adapter

Material: Fusiolen® PP-R, brass

Standard: DIN 16962, DIN EN ISO 15874

Colour: green

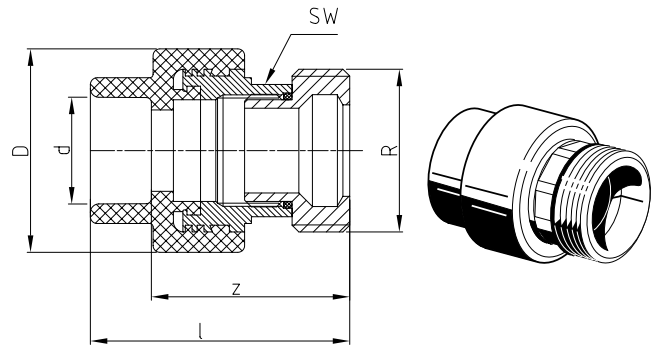

SDR	Art.-No.	d	Thread R	l	z	D	SW	Weight [kg]	PU	Box unit	Price € m/pc
7,4 11	27310	20	1"	61,50	47,00	38,50	24,00	0,151	10	300	
	27311	25	1"	63,00	47,00	38,50	24,00	0,153	10	300	
	27312	25	1 1/4"	63,00	47,00	43,50	31,00	0,221	10	250	
	27313	32	1 1/4"	66,00	48,00	43,50	31,00	0,226	5	175	
	27314	32	1 1/2"	76,50	58,50	60,00	39,00	0,408	5	125	
	27315	40	1 1/2"	79,00	58,50	60,00	39,00	0,414	5	125	
	27316	40	2"	81,00	60,50	74,00	50,00	0,650	5	70	
	27317	50	2"	84,00	60,50	74,00	50,00	0,634	5	70	
	27318	50	2 1/4"	83,00	59,50	84,00	55,00	0,750	5	50	
	27319	63	2 1/4"	89,50	62,00	84,00	55,00	0,728	1	45	
	27320	63	2 3/4"	94,00	66,50	101,00	67,00	1,093	1	30	
	27321	75	2 3/4"	95,00	65,00	100,00	67,00	1,117	1	30	
27322	75	3 1/2"	100,00	70,00	100,00	67,00	1,436	1	30		

BRASS COUNTERPART

with female thread, for ISO-standard adapter / loose nut adapter

Material: Fusiolen® PP-R, brass

Colour: green

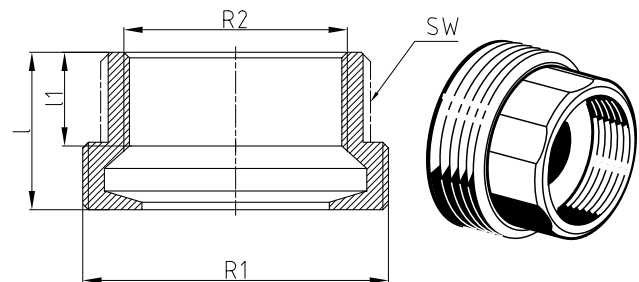

SDR	Art.-No.	Male thread R1	Female thread R2	l	l1	SW	Weight [kg]	PU	Box unit	Price € m/pc
7,4 11	27510	1"	1/2"	25,00	15,00	25,00	0,063	10	400	
	27512	1 1/4"	3/4"	28,00	18,00	32,00	0,119	10	200	
	27514	1 1/2"	1"	31,00	17,00	40,00	0,175	5	125	
	27516	2"	1 1/4"	33,00	22,00	47,00	0,263	5	75	
	27518	2 1/4"	1 1/2"	36,00	19,00	57,00	0,333	5	60	
	27520	2 3/4"	2"	42,00	24,00	68,00	0,517	1	35	
	27522	3 1/2"	2 1/2"	46,00	27,00	84,00	0,801	1	25	
	27524	4"	3"	46,00	27,00	97,00	0,943	1	25	

Notice: aquatherm green and blue pipe-metal compound fittings are manufactured from fusiolen PP-R and brass. Metal inserts, without hex shaped spanner flat, with 1/2" and 3/4" f are also available in stainless steel. aquatherm green pipe stainless steel price list Order- No.: E53180 on request!!

BRASS COUNTERPART

with male thread, for ISO-standard adapter / loose nut adapter

Material: brass
Colour: green

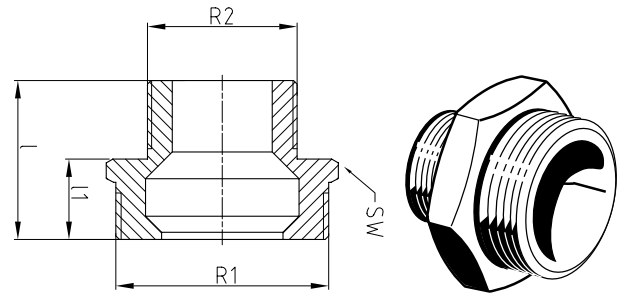

SDR	Art.-No.	Thread R1	Thread R2	l	l1	SW	Weight [kg]	PU	Box unit	Price € m/pc
7,4 11	27710	1"	1/2"	34,50	18,50	36,00	0,109	10	250	
	27712	1 1/4"	3/4"	38,50	21,00	46,00	0,188	10	140	
	27714	1 1/2"	1"	41,50	22,50	50,00	0,211	5	100	
	27716	2"	1 1/4"	44,50	22,50	65,00	3,630	5	60	
	27718	2 1/4"	1 1/2"	58,00	36,00	57,00	0,472	5	50	
	27720	2 3/4"	2"	63,00	38,00	66,00	0,803	1	25	
	27722	3 1/2"	2 1/2"	70,00	42,00	82,00	1,189	1	15	
27724	4"	3"	74,00	42,00	97,00	1,398	1	10		

DISTRIBUTION BLOCK PLUMBING

including 1 plug and 2 fastenings

Material: Fusiolen® PP-R
Colour: green

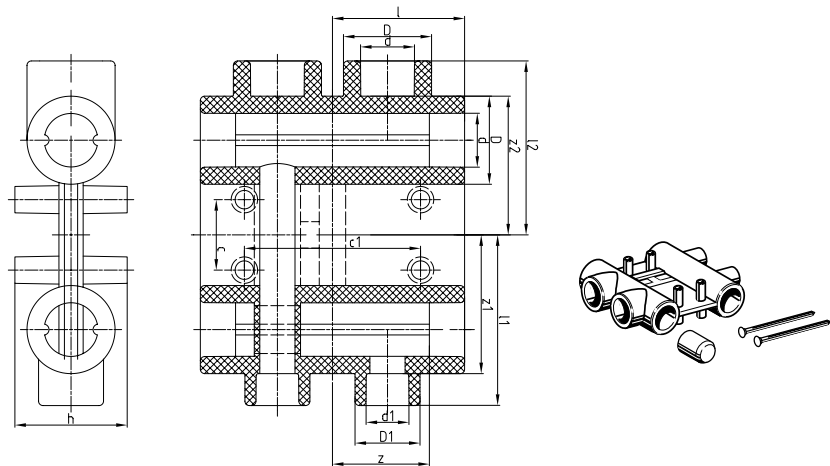

SDR	Art.-No.	d	l	z	D	d1	l1	z1	D1	l2	z2	c	c1	c2	l3	h	Weight [kg]	PU	Box unit	Price € m/pc
6 7,4 11	30115	25	60,00	44,00	40,00	20,00	77,50	63,00	29,50	79,00	63,00	32,00	80,00	100,00	36,00	51,00	0,273	1		

FOUR-PORT MANIFOLD

length: 246 mm, with 4 branches

Material: Fusiolen® PP-R
Colour: green

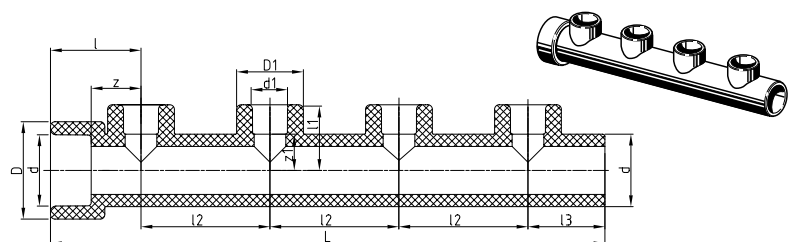

SDR	Art.-No.	d	d1	l	z	D	l1	z1	D1	l2	l3	L	Weight [kg]	PU	Box unit	Price € m/pc
7,4 11	30602	32	16,00	40,00	22,00	43,00	29,00	16,00	29,50	57,00	36,00	245,00	0,141	1		
	30604	32	20,00	40,00	22,00	43,00	29,00	14,50	29,50	57,00	36,00	245,00	0,134	1		

The four-port manifold can be shortened or extended by fusion with further four-port manifolds, if required.

MANIFOLD END PIECE WITH FEMALE THREAD*

Material: Fusiolen® PP-R, brass
 Standard: DIN 16962, DIN EN ISO 15874
 Colour: green

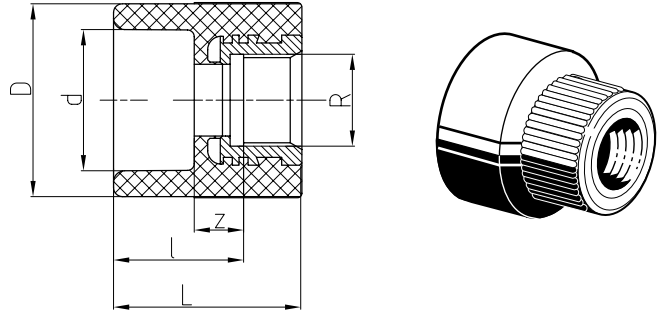

SDR	Art.-No.	d	R	l	z	D	L	Weight [kg]	PU	Box unit	Price € m/pc
7,4											
11	30804	32	1/2"	30,00	12,00	43,00	43,00	0,077	2		

* transition piece as manifold endpiece with female thread

Notice: aquatherm green and blue pipe-metal compound fittings are manufactured from fusiolen PP-R and brass. Metal inserts, without hex shaped spanner flat, with 1/2" and 3/4" f are also available in stainless steel. aquatherm green pipe stainless steel price list Order- No.: E53180 on request!!

BALL VALVE FOR MANIFOLD

female/male

Material: Fusiolen® PP-R, brass
 Colour: green

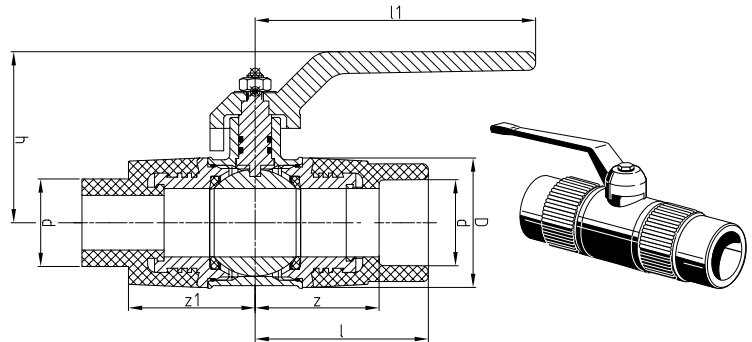

SDR	Art.-No.	d	l	z	D	z1	h	l1	Weight [kg]	PU	Box unit	Price € m/pc
7,4												
11	78000	32	63,00	45,00	47,50	46,50	78,00	108,00	0,575	2	4	

SUPPORTING STRAP FOR FOUR-PORT MANIFOLD

with clamps, galvanized, double

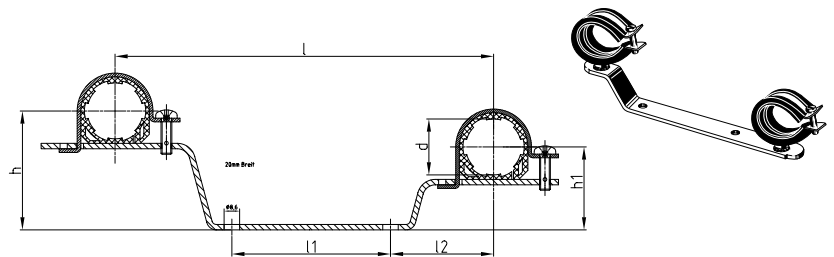

Art.-No.	d	l	l1	l2	h	h1	Weight [kg]	PU	Box unit	Price € m/pc
60210	32	210,00	80,00	57,00	66,00	46,00	0,226	2		

GLOBE VALVE

for surface installation

Material: Fusiolen® PP-R, brass

Colour: green

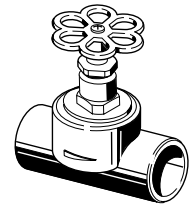
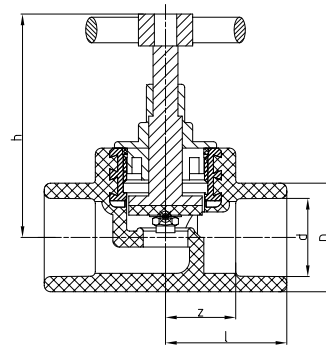

SDR	Art.-No.	d	l	z	D	h	Weight [kg]	PU	Box unit	Price € m/pc
7,4 11	40808	20	35,00	20,50	29,50	70,00	0,165	1	100	
	40810	25	38,00	22,00	34,00	70,00	0,172	1	100	
	40812	32	49,00	31,00	43,00	86,50	0,314	1	60	
	40814	40	60,00	39,50	52,00	100,50	0,585	1	35	

CONCEALED VALVE

chromium plated

Material: Fusiolen® PP-R, brass

Colour: green

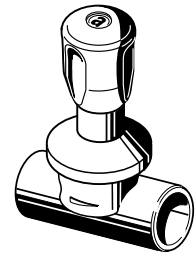
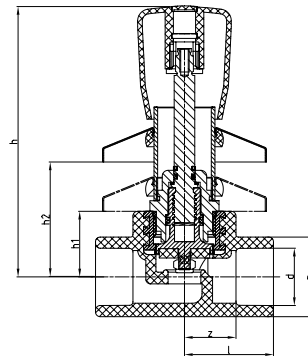

SDR	Art.-No.	d	l	z	D	h	h1	h2	Weight [kg]	PU	Box unit	Price € m/pc
7,4 11	40858	20	35,00	20,50	29,50	116,00	28,00	59,00	0,319	1	40	
	40860	25	38,00	22,00	34,00	116,00	28,00	59,00	0,330	1	40	
	40862	32	49,00	31,00	43,00	121,00	34,00	59,00	0,416	1	30	

CONCEALED VALVE

tamper proof/ chromium-plated/ short design

Material: Fusiolen® PP-R, brass

Colour: green, chrom

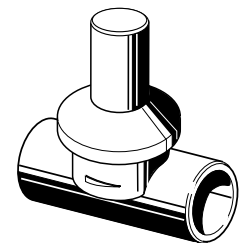
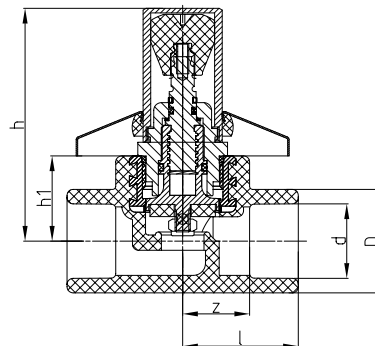

SDR	Art.-No.	d	l	z	D	h	h1	Weight [kg]	PU	Box unit	Price € m/pc
7,4 11	40868	20	35,00	20,50	29,50	71,50	28,00	0,258	1	50	
	40870	25	38,00	22,00	34,00	71,50	28,00	0,288	1	50	
	40872	32	49,00	31,00	43,00	82,50	34,00	0,376	1	30	

CONCEALED VALVE

suitable for construction depth of 55 mm to 100 mm

Material: Fusiolen® PP-R, brass

Colour: green, chrom

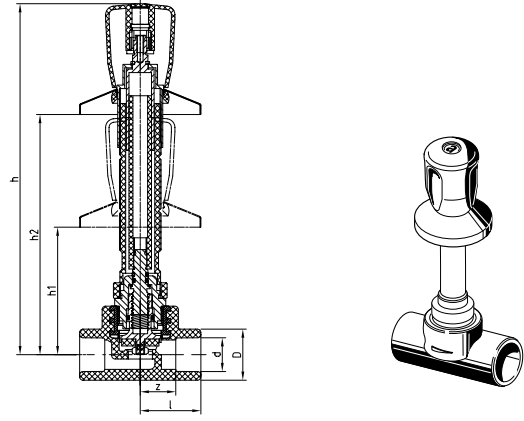

SDR	Art.-No.	d	l	z	D	h	h1	h2	Weight [kg]	PU	Box unit	Price € m/pc
7,4 11	40878	20	35,00	20,50	29,50	213,00	59,00	147,00	0,357	1	40	
	40880	25	38,00	22,00	34,00	213,00	59,00	147,00	0,369	1	40	
	40882	32	49,00	31,00	43,00	219,00	65,00	153,00	0,455	1	20	

CONCEALED VALVE

tamper proof, chromium-plated

Material: Fusiolen® PP-R, brass

Colour: green, chrom

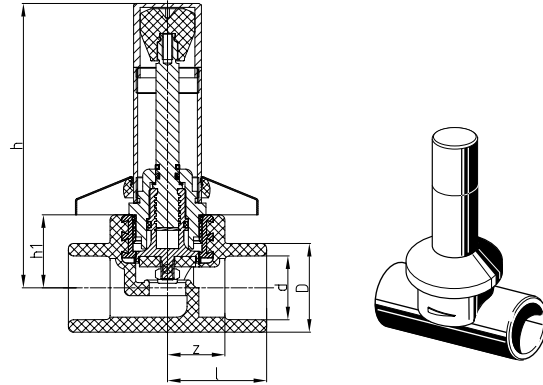

SDR	Art.-No.	d	l	z	D	h	h1	Weight [kg]	PU	Box unit	Price € m/pc
7,4 11	40888	20	35,00	20,50	29,50	109,00	28,00	0,342	1	50	
	40890	25	38,00	22,00	34,00	109,00	28,00	0,350	1	50	
	40892	32	49,00	31,00	43,00	115,00	34,00	0,432	1	40	

EXTENSION FOR CONCEALED VALVE

chromium-plated for Art.-No. 40858-40862

Material: brass

Colour: chrom

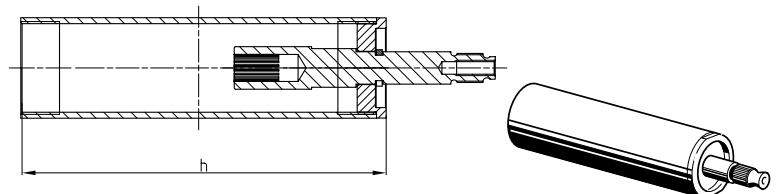

Art.-No.	h	Weight [kg]	PU	Box unit	Price € m/pc
40900	92,00	0,148	1	300	
40902	132,00	0,209	1	200	

STOP VALVE BODY

Material: Fusiolen® PP-R, brass
 Colour: green

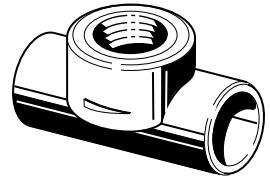
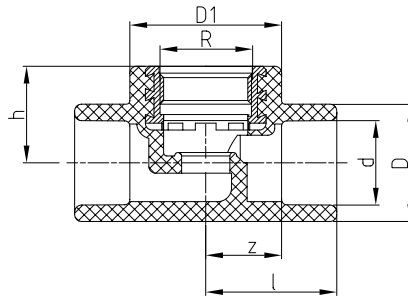

SDR	Art.-No.	d	R	l	z	D	h	D1	Weight [kg]	PU	Box unit	Price € m/pc
7,4 11	40908	20	3/4"	35,00	20,00	29,50	28,00	44,00	0,093	1	150	
	40910	25	3/4"	38,00	22,00	34,00	28,00	44,00	0,101	1	150	
	40912	32	1"	49,00	31,00	43,00	34,00	52,00	0,146	1	100	
	40914	40	1 1/4"	60,00	39,50	52,00	41,00		0,313	1	50	

INCLINED VALVE

without drain

Material: Fusiolen® PP-R, brass
 Colour: green

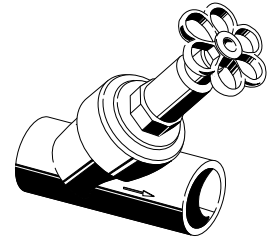
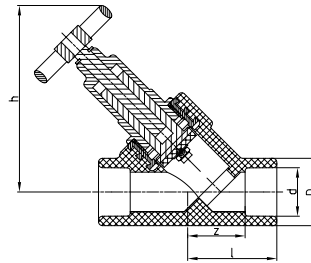

SDR	Art.-No.	d	l	z	D	h	Weight [kg]	PU	Box unit	Price € m/pc
7,4 11	41108	20	45,00	30,50	34,00	95,50	0,294	1	100	
	41110	25	45,00	29,00	34,00	95,50	0,283	1	80	
	41112	32	56,00	38,00	43,00	111,50	0,421	1	50	
	41114	40	65,00	44,50	52,00	135,00	0,834	1	25	

NON-RETURN VALVE

without drain

Material: Fusiolen® PP-R, brass
 Colour: green

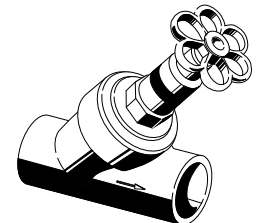
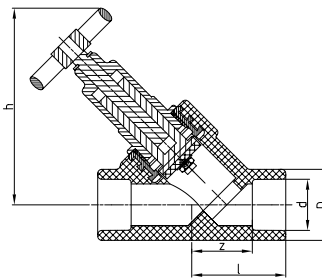

SDR	Art.-No.	d	l	z	D	h	Weight [kg]	PU	Box unit	Price € m/pc
7,4 11	41208	20	45,00	30,50	34,00	95,50	0,297	1	80	
	41210	25	45,00	29,00	34,00	95,50	0,292	1	80	
	41212	32	56,00	38,00	43,00	111,50	0,432	1	50	
	41214	40	65,00	44,50	52,00	135,00	0,840	1	25	

BALL VALVE PP/BRASS

Material: Fusiolen® PP-R, brass
 Colour: green

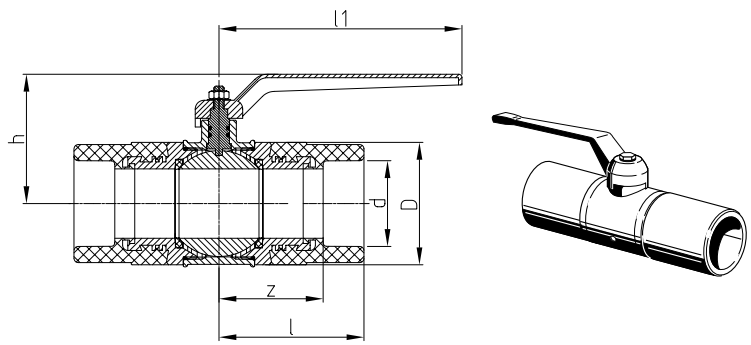

SDR	Art.-No.	d	l	z	D	h	l1	Weight [kg]	PU	Box unit	Price € m/pc
7,4 11	41308	20	55,00	40,50	32,00	66,00	85,00	0,280	1	100	
	41310	25	55,00	39,00	41,00	73,00	85,00	0,375	1	100	
	41312	32	63,50	45,50	47,00	82,00	108,00	0,592	1	60	
	41314	40	72,50	52,00	58,00	93,00	108,00	1,034	1	40	
	41316	50	83,50	60,00	70,50	114,00	140,00	1,339	1	25	
	41318	63	102,50	75,00	87,00	132,00	140,00	2,552	1	15	

EXTENSION FOR AQUATHERM GREEN PIPE-BALL VALVE

chromium-plated for Art.-No. 41308-41318

Material: brass
 Colour: chrom

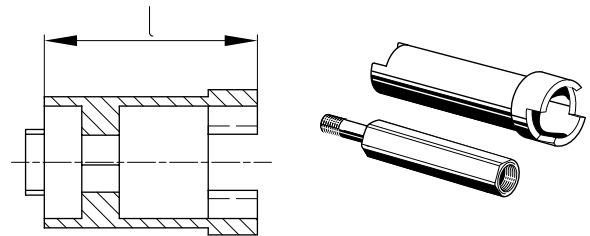

Art.-No.	l	for Art.-No.	Weight [kg]	PU	Box unit	Price € m/pc
41378	35,00	41308 / 41310	0,120	1		
41382	35,00	41312 / 41314	0,120	1		
41386	46,00	41316 / 41318	0,273	1		

PP-BALL VALVE

with union nut and welding socket

Material: Fusiolen® PP-R
 Colour: green

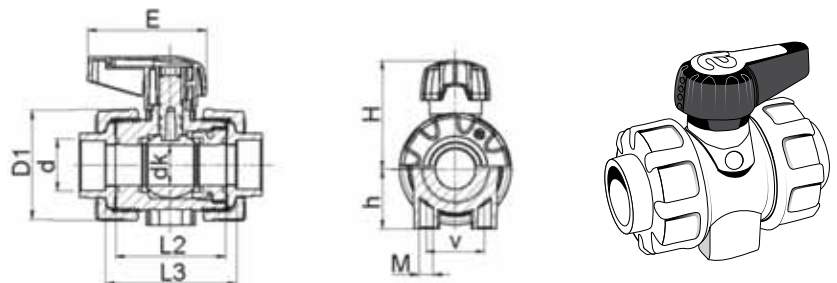

SDR	Art.-No.	d	dk	D1	E	h	H	L2	L3	DN	Weight [kg]	PU	Box unit	Price € m/pc
7,4 11	41488	20	13,5	50,30	66	27,00	48	56,50	68,00	15	0,118	1	200	
	41490	25	18,5	59,00	81	30,00	56,5	65,50	78,50	20	0,188	1	120	
	41492	32	23,9	70,30	81,5	40,00	64,5	72,00	84,50	25	0,277	1	80	
	41494	40	31,0	85,90	91,5	46,00	83,3	85,00	100,00	32	0,434	1	55	
	41496	50	38,5	99,50	91,5	55,00	89,4	89,00	107,00	40	0,549	1	45	
	41498	63	50,0	125,50	141,5	70,00	115	101,00	118,00	50	0,922	1	25	

PP-BALL VALVE

with union nut and welding socket

Material: Fusiolen® PP-R

Colour: green

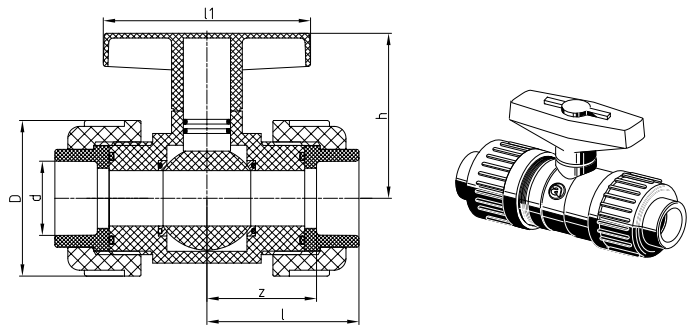

SDR	Art.-No.	d	l	z	D	h	l1	Inch R	DN	Weight [kg]	PU	Box unit	Price € m/pc
7,4 11	41400	75	138,00	108,00	129,00	137,00	186,00		65	2,615	1	10	

PP-BALL VALVE

with flange connection on both sides

Material: Fusiolen® PP-R

Colour: green

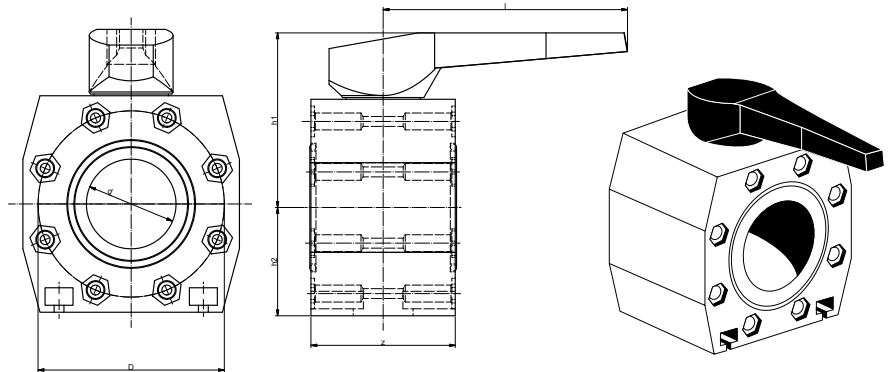

SDR	Art.-No.	for ø	d	l	z	D	h1	h2	DN	Weight [kg]	PU	Box unit	Price € m/pc
7,4 11	41601	75									1		
	41602	90	77	210,00	124,00	160,00	150,00	93,00	80	4,171	1		
	41604	110	94	260,00	145,00	180,00	165,00	103,00	100	5,612	1		
	41607	160	135	310,00	205,00	240,00	210,00	136,50	150	5,615	1		

For dimension 125 mm the PP-ball valve Art.-No. 41604 with flange adapter Art.-No. 15526 and flange Art.-No. 15724 is used.

For connection with aquatherm green pipe-weldable flange adapter (Art.-No. 15520-15531) and aquatherm green pipe plastic coated steel flange (Art.-No. 15720-15730)

Hexagon screw M16x60mm for Art.-No. 41602/41604

Hexagon screw M20x80mm for Art.-No. 41607

corresponding flat washer M16

NOTICE: These are not included in delivery.

DRAINING BRANCH

to weld in aquatherm green pipe valves

Material: Fusiolen® PP-R, brass

Colour: green

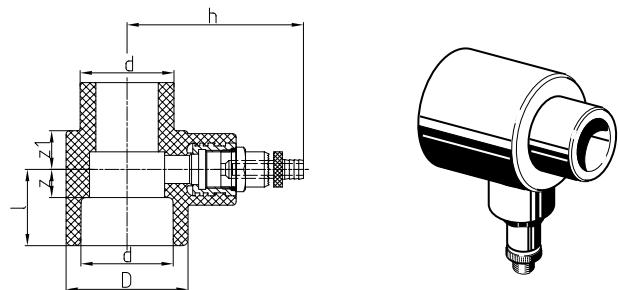

SDR	Art.-No.	d	z	l	D	z1	h	Weight [kg]	PU	Box unit	Price € m/pc
7,4 11	41408	20	11,50	26,00	34,00	16,50	67,00	0,098	1	200	
	41410	25	10,00	26,00	34,00	16,50	67,00	0,096	1	200	
	41412	32	14,00	32,00	43,00	17,00	70,50	0,118	1	150	
	41414	40	12,00	32,50	52,00	16,50	76,50	0,140	1	100	
	41416	50	15,50	39,00	68,00	17,00	83,75	0,202	1	40	
	41418	63	16,50	44,00	84,00	16,50	93,00	0,288	1	25	

Important: Do not cut the aquatherm-pipes with customary hack saws.
aquatherm-pipes can be cut with customary saws equipped with saw blades suitable for plastic.

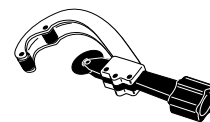

PIPE CUTTER

Art.-No.	for pipe dimensions	PU	Box unit	Price € m/pc
50102	ø 16 - 40 mm	1		
50105	ø 50 - 125 mm	1		
50106	ø 110 - 160 mm	1		

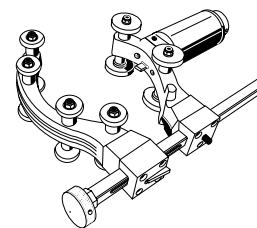

PIPE CUTTER

Art.-No.	for pipe dimensions	PU	Box unit	Price € m/pc
50104	ø 16 - 40 mm	1		

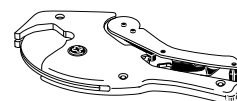

ORBITAL CIRCULAR SAW

Art.-No.	for pipe dimensions	PU	Box unit	Price € m/pc
50108	ø 160 - 355 mm	1		

This orbital circular saw can be ordered directly from Rothenberger with Art.-No. 5.5620 (www.rothenberger.com). High-performance orbital circular saw for fast, precise, perfectly aligned and right-angled cutting of plastic pipes 160 - 355 mm at the building site or in the workshop.

CUTTING DISC FOR PLASTIC

Art.-No.	Dimension	Bohrung	PU	Box unit	Price € m/pc
50107	ø 125 mm	22,2 mm	1		
50109	ø 230 mm	22,2 mm	1		

Application: for each angle grinder
Design: diamant galvanized cutting disc

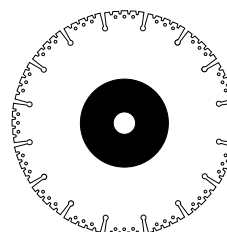

MANUAL WELDING DEVICE (500 W)

Art.-No.	for pipe dimensions	PU	Box unit	Price € m/pc
50336	ø 16 - 32 mm	1		

for one tool
with base and case for tools

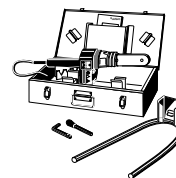

MANUAL WELDING DEVICE (800 W)

Art.-No.	for pipe dimensions	PU	Box unit	Price € m/pc
50337	ø 16 - 63 mm	1		

for two tools
with base and case for tools

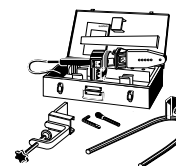

MANUAL WELDING DEVICE (1400 W)

Art.-No.	for pipe dimensions	PU	Box unit	Price € m/pc
50341	ø 50 - 125 mm	1		

with base and case for tools



WELDING MACHINE (1400 W)

Art.-No.	for pipe dimensions	PU	Box unit	Price € m/pc
50148	ø 50 - 125 mm - 230 V	1		

including welding tools 50-125 mm, roll stand and wooden transport case

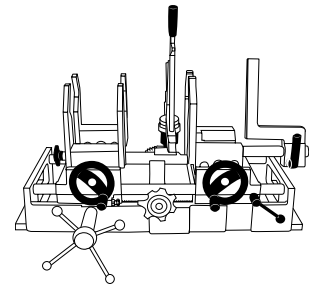

WELDING MACHINE (1400 W) LIGHT

Art.-No.	for pipe dimensions	PU	Box unit	Price € m/pc
50145	ø 63 - 125 mm	1		

including manual welding device (1400 W) and wooden transport case

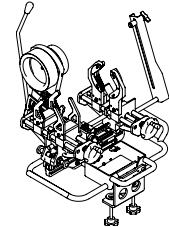

ELECTRIC WELDING JIG

Art.-No.	for pipe dimensions	PU	Box unit	Price € m/pc
50159	ø 63 - 125 mm	1		

including standby accumulator, charging station and metal case

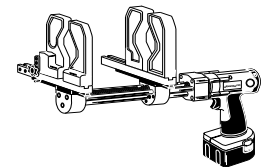

BASE FOR ART.-NO. 50149

Art.-No.	Dimension	PU	Box unit	Price € m/pc
50151		1		

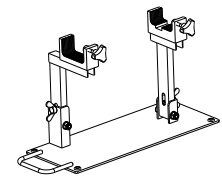

BUTT WELDING MACHINES ROTHENBERGER

Art.-No.	for pipe dimensions	PU	Box unit	Price € m/pc
50163	ø 160 - 250 mm	1		
50167	ø 160 - 315 mm	1		
50178	ø 160 - 355 mm	1		

including wooden transport box.

The butt welding machine can be obtained directly from Rothenberger (www.rothenberger.com)

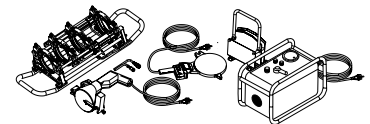

MANUAL WELDING DEVICE (1500 W) FOR SADDLE WELDING Ø 50-160 mm

Art.-No.	for pipe dimensions	PU	Box unit	Price € m/pc
50330	Ø 50 - 160 mm	1		

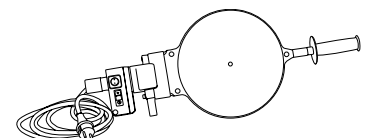

BUTT WELDING MACHINES RITMO

Art.-No.	for pipe dimensions	PU	Box unit	Price € m/pc
50165	ø 160 - 250 mm	1		
50166	ø 160 - 315 mm	1		
50177	ø 160 - 355 mm	1		
50169	ø 400 - 630 mm	1		

including wooden transport box.

The butt welding machine can be obtained directly from Ritmo (www.ritmo.it)

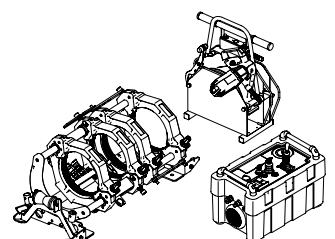

ELECTROFUSION DEVICE

Art.-No.	for pipe dimensions	PU	Box unit	Price € m/pc
50175	ø 20 - 250 mm	1		

For processing with electro-fusion-sockets Art.-No. 17234-17238.
Special calibration-tools - obtainable on request - are required

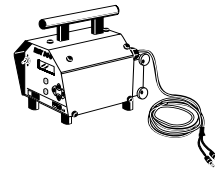

TEMPERATURE PENCIL

Art.-No.	Dimension	PU	Box unit	Price € m/pc
50190		1		

to check the correct welding temperature

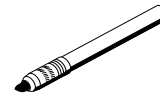

SURFACE THERMOMETER

Art.-No.	Dimension	PU	Box unit	Price € m/pc
50188		1		

to check the correct welding temperature



TEMPERATURE PREDECTIVE GLOVE

for tool change

Art.-No.	Dimension	PU	Box unit	Price € m/pc
50195		2		



CLEANING WIPES

Art.-No.	Dimension	PU	Box unit	Price € m/pc
50193	Box with 100 towels	1		

for electrofusion sockets



WELDING TOOLS

Art.-No.	Dimension	PU	Box unit	Price € m/pc
50206	16 mm	1		
50208	20 mm	1		
50210	25 mm	1		
50212	32 mm	1		
50214	40 mm	1		
50216	50 mm	1		
50218	63 mm	1		
50220	75 mm	1		
50222	90 mm	1		
50224	110 mm	1		
50226	125 mm	1		

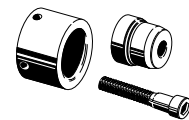

REPAIR SET

Art.-No.	Dimension	PU	Box unit	Price € m/pc
50307	7 mm	1		
50311	11 mm	1		

to close holes of up to 10 mm in the pipe (pipe repair stick Art.-No. 60600)



PIPE REPAIR STICK

for pipe repairs

Art.-No.	Dimension	PU	Box unit	Price € m/pc
60600	7/11 mm	10		

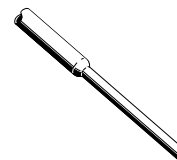

NEW aquatherm UNIVERSAL PEELING TOOLS

for aquatherm blue pipe MF UV and aquatherm blue pipe MF OT

Required for the **socket welding**

(in combination with socket welding fittings from page 118 onwards, e.g. sockets, elbows, T-pieces, transition pieces with thread)



Also suitable for manual peeling (bolts included)

Art.-No.	Dimension	PU	Box unit	Price € m/pc
50479	20 mm	1		
50480	25 mm	1		
50481	32 mm	1		
50482	40 mm	1		
50483	50 mm	1		
50484	63 mm	1		
50485	75 mm	1		
50486	90 mm	1		
50487	110 mm	1		
50488	125 mm	1		

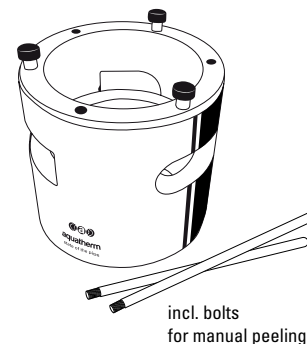

not suitable for aquatherm blue pipe S, aquatherm blue pipe MF and aquatherm blue pipe TI

S = single, **MF** = multilayer faser, **OT** = oxygen tight, **UV** = ultraviolet protected, **TI** = thermal insulation

NEW aquatherm EXTENSION FOR UNIVERSAL PEELING TOOL

Required for the **electrofusion socket welding** (aquatherm electrofusion sockets on page 136)

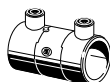

When electrofusion welding a longer welding depth is required, which is achieved by the combination of the universal peeling tool and the extension for the universal peeling tool (e.g. art.-no. 50479+50489)

Art.-No.	Dimension	PU	Box unit	Price € m/pc
50489	for peeling tool 20 mm art.-no. 50479	1		
50490	for peeling tool 25 mm art.-no. 50480	1		
50491	for peeling tool 32 mm art.-no. 50481	1		
50492	for peeling tool 40 mm art.-no. 50482	1		
50493	for peeling tool 50 mm art.-no. 50483	1		
50494	for peeling tool 63 mm art.-no. 50484	1		
50495	for peeling tool 75 mm art.-no. 50485	1		
50496	for peeling tool 90 mm art.-no. 50486	1		
50497	for peeling tool 110 mm art.-no. 50487	1		
50498	for peeling tool 125 mm art.-no. 50488	1		

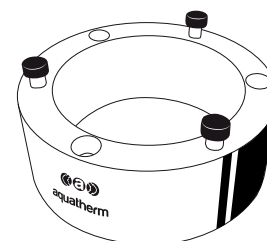

NEW ATTACHMENT PLATE FOR UNIVERSAL PEELING TOOL

In combination with or without extension for universal peeling tools for drilling machine

Art.-No.	Dimension	PU	Box unit	Price € m/pc
50499	for universal peeling tool 50479 – 50484	1	3	
50500	for universal peeling tool 50485 – 50488	1	3	

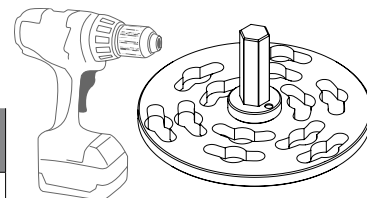

Delivery without drilling machine!

aquatherm PEELING TOOLS FOR ELECTROFUSION SOCKET WELDING (Art.-No.17208-17238)

for aquatherm aquatherm blue pipe S, aquatherm blue pipe MF and aquatherm blue pipe MFTI

Required to remove the **oxid coating**

(aquatherm electrofusion sockets on page 132)

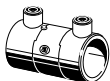

Art.-No.	Dimension	PU	Box unit	Price € m/pc
In combination with a drilling machine				
50558	20 mm	1		
50560	25 mm	1		
50562	32 mm	1		
50564	40 mm	1		
50566	50 mm	1		
50568	63 mm	1		
50570	75 mm	1		
50572	90 mm	1		

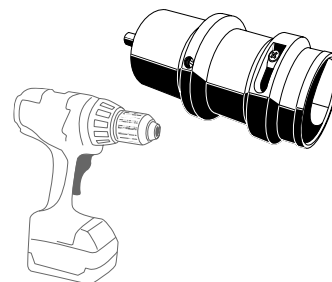

Art.-No. 50558-50572

In combination with a drilling machine (not included!)

For manual peeling				
50574	110 mm	1		
50576	125 mm	1		
50580	160 mm	1		

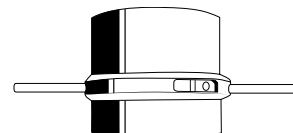

Art.-No. 50574-50580

For manual peeling				
50592	200 + 250 mm	1		

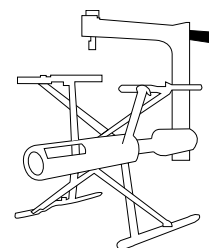

Art.-No. 50592

Not suitable for aquatherm blue pipe UV and aquatherm blue pipe OT

S = single, MF = multilayer faser, OT = oxygen tight, UV = ultraviolet protected, TI = thermal insulation

Spare parts such as blades can be requested under service@aquatherm.de!

SADDLE WELDING TOOLS

for aquatherm welding saddles

Art.-No.	Dimension	PU	Box unit	Price € m/pc
50614	40 x 20/25 mm	1		
50616	50 x 20/25 mm	1		
50619	63 x 20/25 mm	1		
50620	63 x 32 mm	1		
50623	75 x 20/25 mm	1		
50624	75 x 32 mm	1		
50625	75 x 40 mm	1		
50627	90 x 20/25 mm	1		
50628	90 x 32 mm	1		
50629	90 x 40 mm	1		
50631	110 x 20/25 mm	1		
50632	110 x 32 mm	1		
50634	110 x 40 mm	1		
50635	110 x 50 mm	1		
50636	125 x 20/25 mm	1		
50638	125 x 32 mm	1		
50640	125 x 40 mm	1		
50642	125 x 50 mm	1		
50644	125 x 63 mm	1		
50648	160 x 20/25 mm	1		
50650	160 x 32 mm	1		
50652	160 x 40 mm	1		
50654	160 x 50 mm	1		
50656	160 x 63 mm	1		
50657	160 x 75 mm	1		
50658	160 x 90 mm	1		
50660	200 x 20/25 mm	1		
50662	200 x 32 mm	1		
50664	200 x 40 mm	1		
50666	200 x 50 mm	1		
50667	200 x 75 mm	1		
50668	200 x 63 mm	1		
50669	200 x 90 mm	1		
50670	200 x 110 mm	1		
50671	200 x 125 mm	1		
50672	250 x 20/25 mm	1		
50674	250 x 32 mm	1		
50676	250 x 40 mm	1		
50678	250 x 50 mm	1		
50680	250 x 63 mm	1		
50682	250 x 75 mm	1		

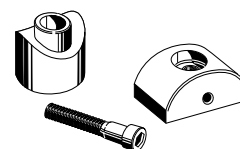

SADDLE WELDING TOOLS

for aquatherm welding saddles

Art.-No.	Dimension	PU	Box unit	Price € m/pc
50684	250 x 90 mm	1		
50686	250 x 110 mm	1		
50688	250 x 125 mm	1		
50690	315 x 63 mm	1		
50692	315 x 75 mm	1		
50694	315 x 90 mm	1		
50696	315 x 110 mm	1		
50698	315 x 125 mm	1		
50699	315 x 160 mm	1		
50712	355 x 63 mm	1		
50714	355 x 75 mm	1		
50716	355 x 90 mm	1		
50718	355 x 110 mm	1		
50720	355 x 125 mm	1		
50722	355 x 160 mm	1		
50726	400-630 x 63 mm	1		
50728	400-500 x 75 mm	1		
50730	560-630 x 75 mm	1		
50732	400-500 x 90 mm	1		
50734	560-630 x 90 mm	1		
50736	400-450 x 110 mm	1		
50738	500-560 x 110 mm	1		
50740	630 x 110 mm	1		
50742	400 x 125 mm	1		
50744	450-500 x 125 mm	1		
50746	560-630 x 125 mm	1		

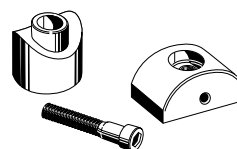

DRILLS for installation of weld-in saddles

Art.-No.	Dimension	PU	Box unit	Price € m/pc
50940	20 & 25 mm (for pipes 50 - 160 mm)	1		
50941	20 & 25 mm (for pipes 63 - 250 mm)	1		
50942	32 mm	1		
50944	40 mm	1		
50946*	50 mm	1		
50948*	63 mm	1		
50950**/**	75 mm	1		
50952**/**	90 mm	1		
50954**/**	110 mm	1		
50956**/**	125 mm	1		
50958**/**	160 mm	1		

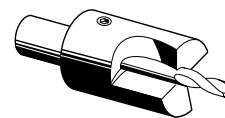

* may only be used in fixed drilling machines!



** tool holder MK4

SADDLE PEELING TOOLS FOR aquatherm blue pipe OT PIPES ø 50-125mm

Art.-No.	Dimension	PU	Box unit	Price € m/pc
50921	for welding saddles 20 & 25 mm for pipe dimensions from 50 mm	1		
50922	for ø 32 mm	1		
50924	for ø 40 mm	1		
50926	for ø 50 mm	1		
50928	for ø 63 mm	1		

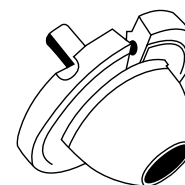

SADDLE PEELING TOOLS FOR aquatherm blue pipe OT PIPES ø 160-250mm

Art.-No.	Dimension	PU	Box unit	Price € m/pc
50421	for welding saddles ø 20 & 25 mm		1	
50422	for welding saddles ø 32 mm		1	
50424	for welding saddles ø 40 mm		1	
50426	for welding saddles ø 50 mm		1	
50428	for welding saddles ø 63 mm		1	

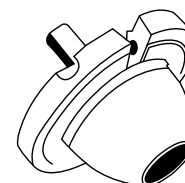



Management
System
ISO 9001:2008
ISO 14001:2004
ISO 50001:2011
www.tuv.com
ID 0091005348

aquatherm GmbH

Biggen 5 | D-57439 Attendorn | Phone: +49 (0) 2722 950-0 | Fax: +49 (0) 2722 950-100

Wilhelm-Rönsch-Str. 4 | D-01454 Radeberg | Phone: +49 (0) 3528 4362-0 | Fax: +49 (0) 3528 4362-30

info@aquatherm.de www.aquatherm.de